

Report of the second WHO stakeholders meeting on gambiense human African trypanosomiasis elimination

Geneva, 21–23 March 2016



WHO Library Cataloguing-in-Publication Data:

Report of the second WHO stakeholders meeting on gambiense human African trypanosomiasis elimination, Geneva, 21-23 March 2016.

1. Trypanosomiasis, African – prevention and control. 2. Trypanosoma brucei gambiense. 3. Disease Eradication. 4. Meeting Abstracts. I. World Health Organization.

ISBN 978 92 4 151152 0

(NLM classification: WC 705)

© World Health Organization 2016

All rights reserved. Publications of the World Health Organization are available on the WHO website (<http://www.who.int>) or can be purchased from WHO Press, World Health Organization, 20 Avenue Appia, 1211 Geneva 27, Switzerland (tel.: +41 22 791 3264; fax: +41 22 791 4857; email: bookorders@who.int).

Requests for permission to reproduce or translate WHO publications – whether for sale or for non-commercial distribution – should be addressed to WHO Press through the WHO website (http://www.who.int/about/licensing/copyright_form/en/index.html).

The designations employed and the presentation of the material in this publication do not imply the expression of any opinion whatsoever on the part of the World Health Organization concerning the legal status of any country, territory, city or area or of its authorities, or concerning the delimitation of its frontiers or boundaries. Dotted and dashed lines on maps represent approximate border lines for which there may not yet be full agreement.

The mention of specific companies or of certain manufacturers' products does not imply that they are endorsed or recommended by the World Health Organization in preference to others of a similar nature that are not mentioned. Errors and omissions excepted, the names of proprietary products are distinguished by initial capital letters.

All reasonable precautions have been taken by the World Health Organization to verify the information contained in this publication. However, the published material is being distributed without warranty of any kind, either expressed or implied. The responsibility for the interpretation and use of the material lies with the reader. In no event shall the World Health Organization be liable for damages arising from its use.

Printed by the WHO Document Production Services, Geneva, Switzerland

WHO/HTM/NTD/IDM/2016.4

Cover page: Illustration from the original "Le ganglion" by Nestor Favre-Mossier

Contents

Abbreviations	iv
1. Introduction	1
2. Meeting objectives	2
3. Opening remarks	2
4. Progress on elimination of gambiense human African trypanosomiasis	2
4.1 Reported cases	3
4.2 Geographical distribution of cases	4
4.3 Population at risk	6
4.4 Area at risk	7
5. Status reports	8
5.1 Country reports	8
5.2 Reports from nongovernmental organizations	13
6. WHO Network for gambiense HAT elimination report 2014–2016	14
7. Control and surveillance: the state of the art and challenges	15
7.1 Screening and diagnosis	15
7.2 Treatment	19
7.3 Epidemiological tools	23
7.4 Vector control	31
8. Assessment of elimination	32
8.1 Verification and validation	32
8.2 Passive surveillance: the experience of West Africa	35
8.3 Challenges of integrated control and surveillance	35
9. Open floor for stakeholders	36
10. Conclusions	38
Annex 1. Agenda	40
Annex 2. List of participants	42

Abbreviations

BMGF	Bill & Melinda Gates Foundation
CATT	card agglutination test for trypanosomiasis
CIRDES	Centre International de Recherche-Développement sur l'Élevage en zone Subhumide (International Centre for Research and Development on Breeding in Subhumid Area)
COCTU	Coordinating Office for Control of Trypanosomiasis in Uganda
CSF	Cerebrospinal fluid
CTC	capillary tube centrifugation
DITECT HAT	Diagnostic Tools for Human African Trypanosomiasis Elimination and Clinical Trials Project
DND <i>i</i>	Drugs for Neglected Diseases <i>initiative</i>
FAO	Food and Agriculture Organization of the United Nations
FIND	Foundation for Innovative New Diagnostics
GE Healthcare	General Electrics Healthcare
HAT	human African trypanosomiasis
HAT-e-TAG	Technical Advisory Group for HAT elimination
IAEA	International Atomic Energy Agency
ICIPE	International Centre of Insect Physiology and Ecology
INRB	Institut National de Recherche Biomédicale (National Institute for Biomedical Research)
IRD	Institut de Recherche pour le Développement (Institute of Research for Development)
ITM	Institute of Tropical Medicine of Antwerp
LAMP	Loop-mediated isothermal amplification
LSTM	Liverpool School of Tropical Medicine
mAECT	mini anion exchange column test
MSC	modified single centrifugation
MSF	Médecins Sans Frontières (Doctors without borders)
NECT	nifurtimox–eflornithine combination therapy
PAAT	Programme Against African Trypanosomiasis
PATTEC	Pan-African Tsetse and Trypanosomiasis Eradication Campaign
PNETHA	Programme National d'élimination de la trypanosomiasis humaine africaine (HAT national elimination programme)
PNLTHA	Programme National de lutte contre la trypanosomiasis humaine africaine (HAT national control programme)
RDT	rapid diagnostic test
RIME LAMP	Loop-mediated isothermal amplification of the random insertion mobile element
SEEG	Spatial Ecology & Epidemiology Group, University of Oxford
SL RNA	Spliced leader RNA
SSNCP	sleeping sickness national control programme (PNLTHA in French)
WBC	white blood cell
WHO	World Health Organization

1. Introduction

Joint efforts by the World Health Organization (WHO) and partners since 2000 have led to the inclusion of human African trypanosomiasis (HAT) on the agenda of neglected tropical diseases targeted for elimination as a public health problem. Important milestones towards elimination have been achieved. Effective collaboration among partners has contributed to building a consistent network of academia, public–private partnerships, nongovernmental organizations, donors and national HAT programmes, under the auspices and coordination of WHO.

In 2011, the WHO Strategic and Technical Advisory Group for Neglected Tropical Diseases established the goal to eliminate HAT as a public health problem by 2020. Efforts were concentrated on the gambiense form of sleeping sickness, which accounts for 98% of the global burden of the disease. The Sixty-sixth World Health Assembly endorsed this goal in resolution WHA66.12 on neglected tropical diseases adopted in 2013, providing an international mandate to work towards elimination.

In 2013, a WHO Expert Committee formulated an elimination strategy and issued updated recommendations on the use of epidemiological (including high-quality mapping), diagnostic, treatment and vector control tools.¹

In 2014, WHO convened the main stakeholders involved in the gambiense HAT elimination objective in order to strengthen the mechanisms of collaboration among the multiple partners. The meeting reviewed the epidemiological situation and existing challenges, refined the objectives for control, and identified the gaps in basic and implementation research to be filled to achieve elimination.

Also in 2014, a WHO network for gambiense HAT elimination was created to coordinate, harmonize and optimize synergies among sleeping sickness national control programmes, international organizations, donors, foundations and nongovernmental organizations, and scientific institutions developing new tools.² The network meets biennially and commissions groups to address the various aspects of elimination. These include annual country progress meetings, a scientific consultative group and an implementation coordination group (divided into five subgroups on development of new tools; operational research; ad-hoc country coordination; advocacy and financial resource mobilization; and integration of new tools into national and global policies). For rhodesiense HAT, a similar but simpler structure was created in October 2014.^{3,4}

During the past 2 years the working groups have met and built the necessary dynamic among the multiple partners as well as the many facets, methodologies and strategies needed to attain elimination. The progress reports of each working group of the WHO Network for HAT elimination⁵ formed the basis for the agenda of the second WHO stakeholders meeting on the elimination of gambiense HAT (Geneva, 21–23 March 2016).

¹ Control and surveillance of human African trypanosomiasis: report of a WHO Expert Committee. Geneva: World Health Organization; 2013 (WHO Technical Report Series, No. 984).

² Holmes P. First WHO meeting of stakeholders on elimination of gambiense human African trypanosomiasis. *PLoS Negl Trop Dis.* 2014 Oct; 8(10):e3244.

³ Holmes P. On the road to elimination of rhodesiense human African trypanosomiasis: first WHO meeting of stakeholders. *PLoS Negl Trop Dis.* 2015 Apr; 9(4):e0003571.

⁴ Report of the first WHO stakeholders meeting on rhodesiense human African trypanosomiasis Geneva, 20–22 October 2014. Geneva: World Health Organization; 2014.

⁵ Report of a WHO meeting on elimination of African trypanosomiasis (*Trypanosoma brucei gambiense*). Geneva, 3–5 December 2012. Geneva: World Health Organization; 2013.

2. Meeting objectives

The objectives of the meeting were:

- to maintain the commitment of national authorities and technical and financial partners to WHO's elimination objective for gambiense HAT;
- to share and assess achievements, challenges and views on the elimination goal among countries and implementing partners since the first meeting held in 2014;
- to assess the status of critical technical aspects in research and development of therapeutic and diagnostic tools, epidemiology and vector control; and
- to analyse and discuss the collaboration and coordination among stakeholders during the past 2 years and for the future.

3. Opening remarks

Dr Minghui Ren, WHO Assistant Director-General for HIV/AIDS, Tuberculosis, Malaria and Neglected Tropical Diseases, opened the meeting by highlighting the commitment of the Organization and all the partners involved in the elimination of sleeping sickness and other neglected tropical diseases.

Dr Abdoulaye Diarra, on behalf of the Regional Adviser for neglected tropical diseases, WHO Regional Office for Africa, stressed the importance of coordinated interactions and efforts among all the partners involved in HAT control and elimination, and the increasing support needed by the endemic countries as the 2020 elimination goal approaches.

Dr Daniel Dagne, Coordinator of the Innovative and Intensified Disease Management unit, WHO Department of Control of Neglected Tropical Diseases, recalled the partnership-building efforts of the past 15 years that have yielded a sustained reduction in the numbers of cases and created a solid perspective for HAT elimination within the defined timeframe.

The chair was assumed by Dr Jorge Seixas, co-chaired by Dr Anne Moore. The meeting agenda is attached as Annex 1 and the list of participants as Annex 2.

4. Progress on elimination of gambiense human African trypanosomiasis

National programmes and their partners have sustained a good level of control activities since the first stakeholders' meeting (Geneva, 25–27 March 2014), as reflected in the country reports and other documents. Progress is reviewed every year in a dedicated meeting convened by WHO of all national programme directors and focal points, allowing a regular inventory of the situation.

Substantive progress is evident. However, in order to properly monitor progress, a correct, continuous and reliable measurement of epidemiological indicators is increasingly important. WHO evaluates progress in HAT control according to the following indicators:

- numbers of cases reported
- geographical distribution of cases
- population at risk
- coverage of population at risk (diagnosis and treatment).

(WHO/HTM/NTD/IDM/2013.4)

(http://apps.who.int/iris/bitstream/10665/79689/1/WHO_HTM_NTD_IDM_2013.4_eng.pdf).

The quantity and quality of the data available to monitor these indicators are considered satisfactory at present. The database of the HAT Atlas (jointly implemented by WHO and the Food and Agriculture Organization of the United Nations [FAO]) is an important tool to analyse in time and space the distribution of the disease. The Atlas captures data collected during 2000–2014 on health facilities performing passive surveillance and active screening performed by mobile teams and on the numbers of new HAT cases reported. It includes 35 239 geolocations and 203 198 cases reported in the past 15 years, 94% of which have been mapped at the village level.

Although data are available to assess regularly the situation in most endemic areas, a few “grey zones” remain where adequate strategies are needed to improve epidemiological knowledge.

The key elements needed to achieve the intermediate goal (elimination of HAT as a public health problem by 2020) and the final goal (interruption of transmission of gambiense HAT (sustainable elimination), by 2030) are:

- to support disease endemic countries to ensure access to diagnosis and treatment for populations at risk;
- to strengthen surveillance, and collect and analyse data in order to plan and monitor interventions and to document and follow-up the epidemiological evolution of the disease, including improving knowledge in grey zones; and
- to coordinate the efforts of stakeholders involved in HAT elimination.

4.1 Reported cases

The numbers of cases of gambiense HAT reported to WHO have followed a decreasing trend since 2001, with a reduction of 86% by 2014. Fewer than 5000 cases were reported annually in 2014 and 2015 (the data for 2015 are still under validation) (Figure 1).

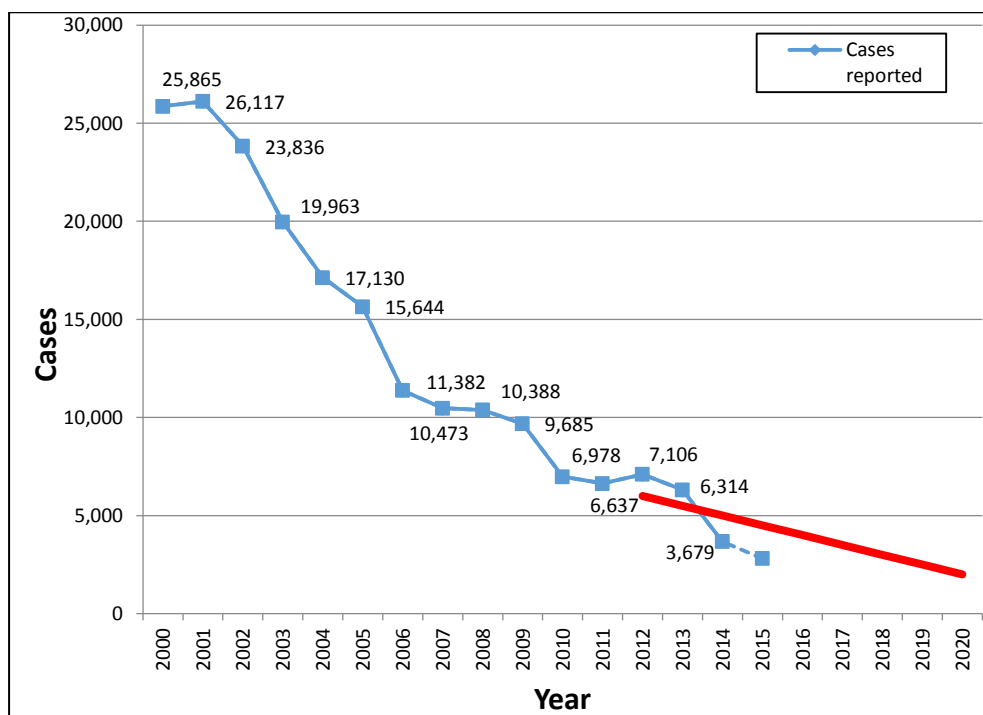

Figure 1. Progression towards gambiense HAT elimination: numbers of cases reported in 2000–2015 and benchmark of number of cases expected in 2012–2020

Fortunately, the sustained decrease in the numbers of reported cases is not a consequence of decreasing surveillance activities: rather, the numbers of people screened have been maintained at the same level (Figure 2) and the numbers of health facilities with capacity to screen, diagnose and treat HAT have been increasing annually, improving access to diagnosis.

It is considered therefore that such a decrease reflects the reality of transmission in the field, and results from sustained active and passive screening in the gambiense HAT endemic countries.

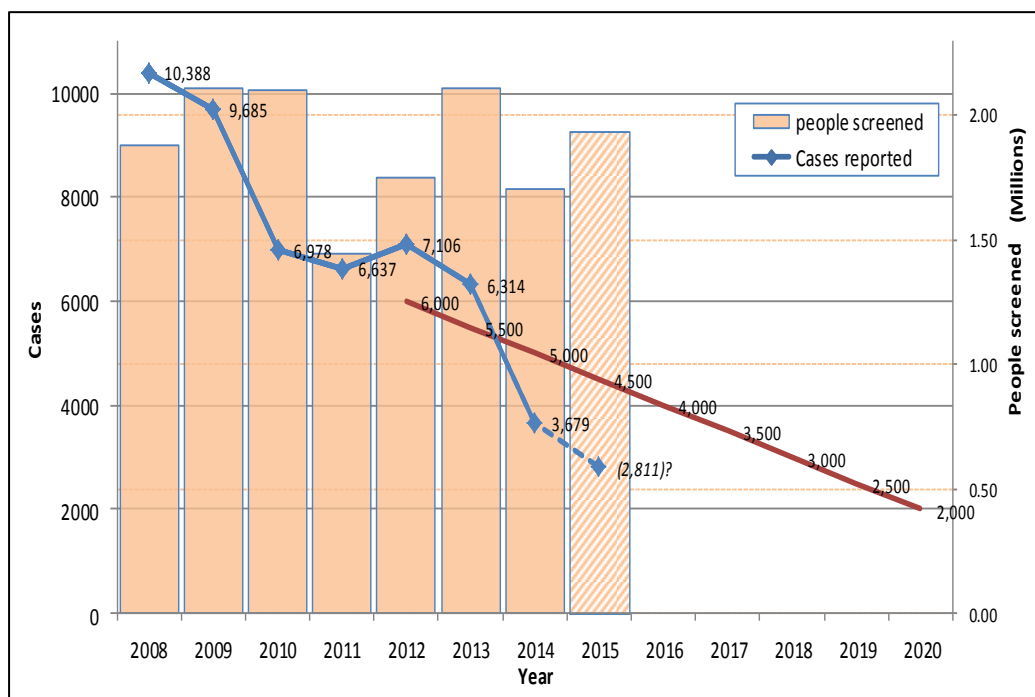

Figure 2. Numbers of people screened and numbers of reported cases, globally; the red line is the benchmark of numbers of cases expected from 2012 to 2020

The WHO roadmap (2012) set a benchmark for elimination with targets for the annual numbers of reported cases from 2012 to 2020. In 2012 and 2013 higher numbers of cases were reported than the milestone figures. This increase was mainly due to the improvement of security in Oriental Province (Democratic Republic of the Congo) and the Ouham focus (Central African Republic), facilitating access to areas that had not been visited for some years and to the detection of cumulated cases that had been infected for several years. At the same time, the case definition used in areas of Oriental Province was discordant with that used by the national programme (PNLTHA) of the Democratic Republic of the Congo, producing a considerable overdiagnosis of cases. However, the numbers of cases for 2014 and 2015 (data still not fully verified) are well below the milestone figures (Figure 2).

4.2 Geographical distribution of cases

Cases of HAT have been mapped at the village level since 2000 and a total of 206 585 HAT cases has been included in the HAT Atlas database up to 2014. The locations of active screening activities where no cases were detected are also included. Figure 3 shows the distribution of cases cumulated by 5-year periods (2000–2004, 2005–2009, 2010–2014). The

evolution in the distribution of cases shows a progressive reduction in those areas presenting cases; the emergence of cases in new areas is extremely rare.

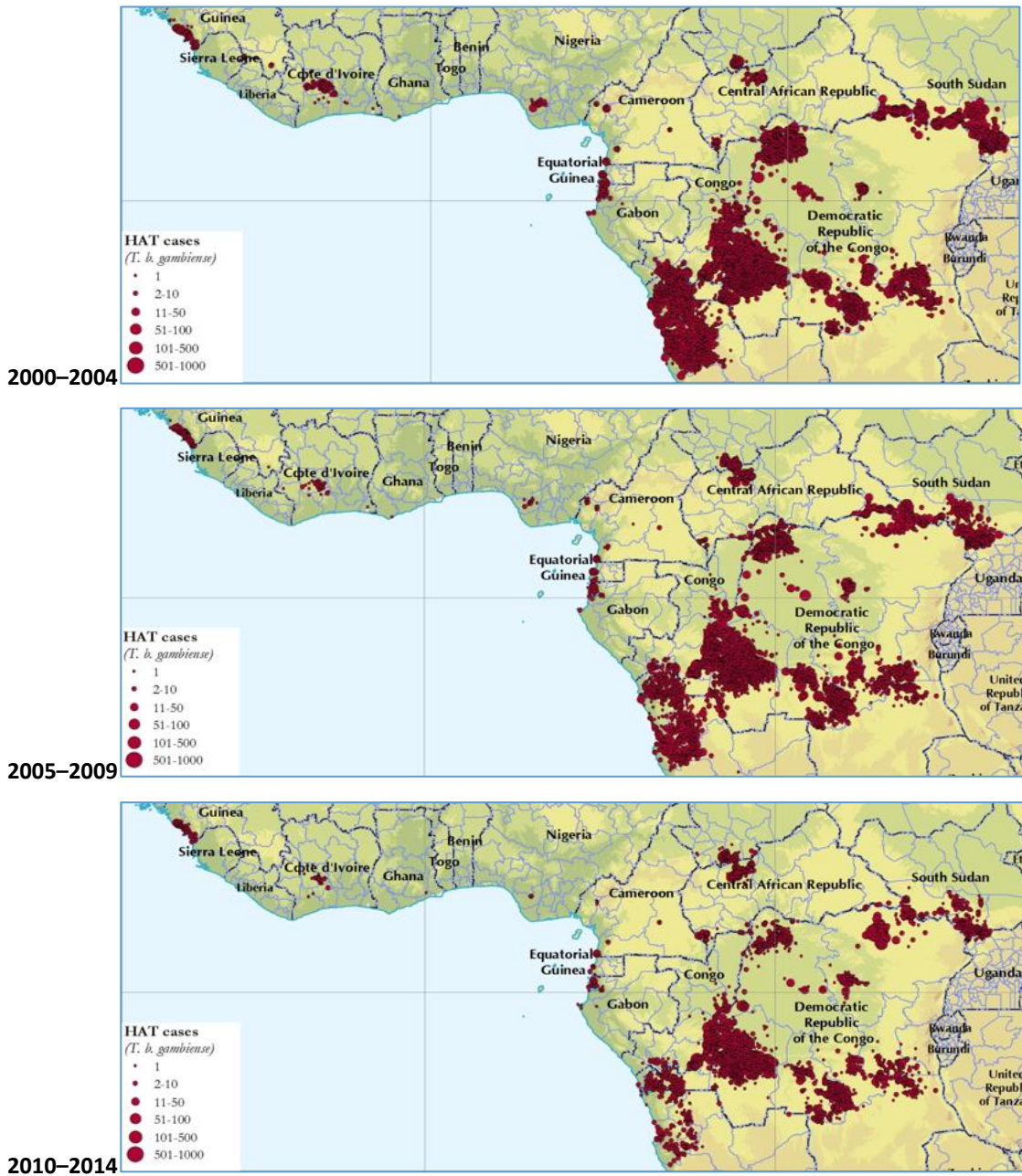

Figure 3. Geographical distribution of gambiense HAT cases, cumulated by 5-year periods

In West Africa transmission continues in Guinea and Côte d'Ivoire, with a decrease in the numbers of cases. A marked decrease in reported cases was registered in 2014 in Guinea which was due to the reduction in case-finding activities during the outbreak of Ebola virus disease. In Nigeria, cases are occasionally reported. One case was detected in Ghana in 2013 after more than 10 years without any reported infection. Elsewhere, no HAT case was diagnosed in the period 2010–2014.

In Central Africa the number of reported cases in Cameroon, Chad, Congo, Equatorial Guinea and Gabon shows a decreasing trend. In the Central African Republic the same trend is

observed but its progression must be considered carefully as active screening activities have been weak in the Haut Mbomou and Ouham prefectures due to security constraints. In Southern Chad (Maro), cases have been reported from a previously silent area.

In Uganda and South Sudan the number of reported cases has declined dramatically. Although reinforced case detection activities in Uganda make plausible a real decline in transmission, in South Sudan the figures must be interpreted with caution because of the diminishing intensity of screening and surveillance activities.

In Angola and the Democratic Republic of the Congo the number of reported cases has decreased steadily. The reported trend is likely to reflect a real reduction in the numbers of infections. Nevertheless, the Democratic Republic of the Congo remains the country with the highest burden of this disease.

4.3 Population at risk

The definition of HAT risk (R) is based on two variables:

- D = mean annual disease intensity
- P = mean annual population intensity

Intensity surfaces D and P are estimated through the “spatial smoothing” technique, using a search radius of 30 km.

Risk is expressed in five different categories: very high, high, moderate, low, very low and marginal (Figure 4).





Category	R = D / P	HAT cases per annum	Colour
Very high	$R > 10^{-2}$	≥ 1 per 10^2 people	
High	$10^{-3} < R < 10^{-2}$	≥ 1 per 10^3 people AND < 1 per 10^2 people	
Moderate	$10^{-4} < R < 10^{-3}$	≥ 1 per 10^4 people AND < 1 per 10^3 people	
Low	$10^{-5} < R < 10^{-4}$	≥ 1 per 10^5 people AND < 1 per 10^4 people	
Very low	$10^{-6} < R < 10^{-5}$	≥ 1 per 10^6 people AND < 1 per 10^5 people	
Marginal	$R < 10^{-6}$	< 1 per 10^6 people	

Figure 4. Categories of population at risk of *Trypanosoma brucei gambiense* infection

In the period 2010–2014, some 55.1 million people at continental level were estimated to be at risk of infection: 1.2 million were at very high and high risk, and 9.2 million at moderate risk. Therefore, 10.4 million people lived in areas where gambiense HAT is still considered a public health problem. Compared with the former 5-year periods, substantial numbers of people have shifted from higher risk to lower risk categories. People exposed to very high, high and moderate risk decreased by 6 million from 2009 to 2014. The most dramatic reduction was in the very high and high risk category, which in the 10-year period from 2004 to 2014 decreased by 79%, from 5.66 million to 1.21 million people (Figure 5).

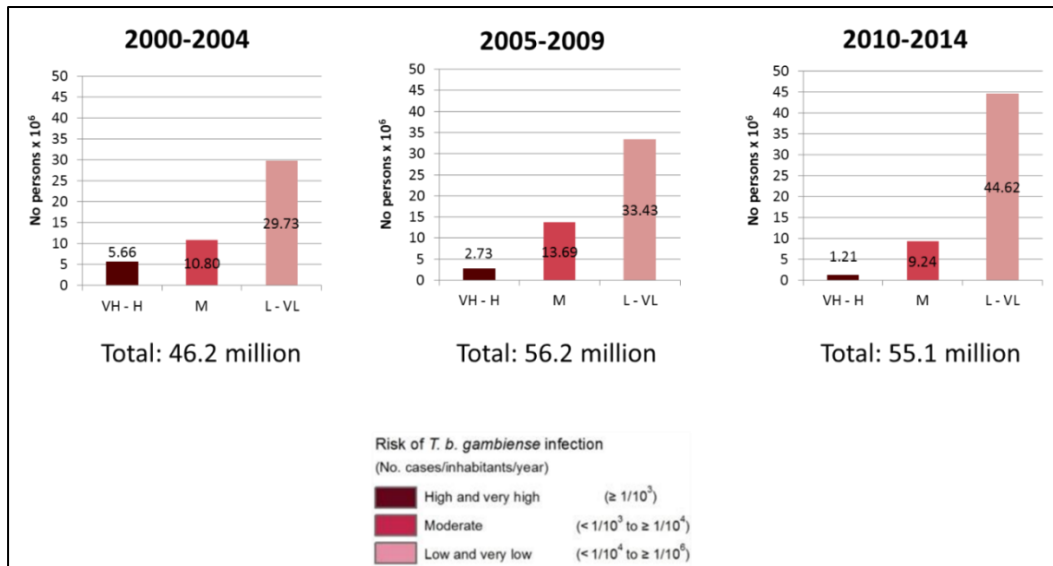

Figure 5. Population at risk of *Trypanosoma brucei gambiense* infection, by level of risk in 2000–2004, 2005–2009 and 2010–2014

4.4 Area at risk

Areas at risk of infection also showed a marked and steady reduction in all risk categories. The decrease was more marked in the very high and high risk category. Figure 6 shows the evolution of areas at risk of gambiense HAT infection between 2000 and 2014 as estimated through a 5-year moving window (starting in 2000–2004 and ending in 2010–2014). The value of each window is plotted at the end year of the window. The dotted line represents the total area corresponding to the definition of “HAT as a public health problem” (i.e. moderate or higher risk); the other lines show the evolution of the moderate risk area and the higher risk areas. By 2014, almost 60 000 km² were estimated to be at very high and high risk, and almost 280 000 km² at moderate risk.

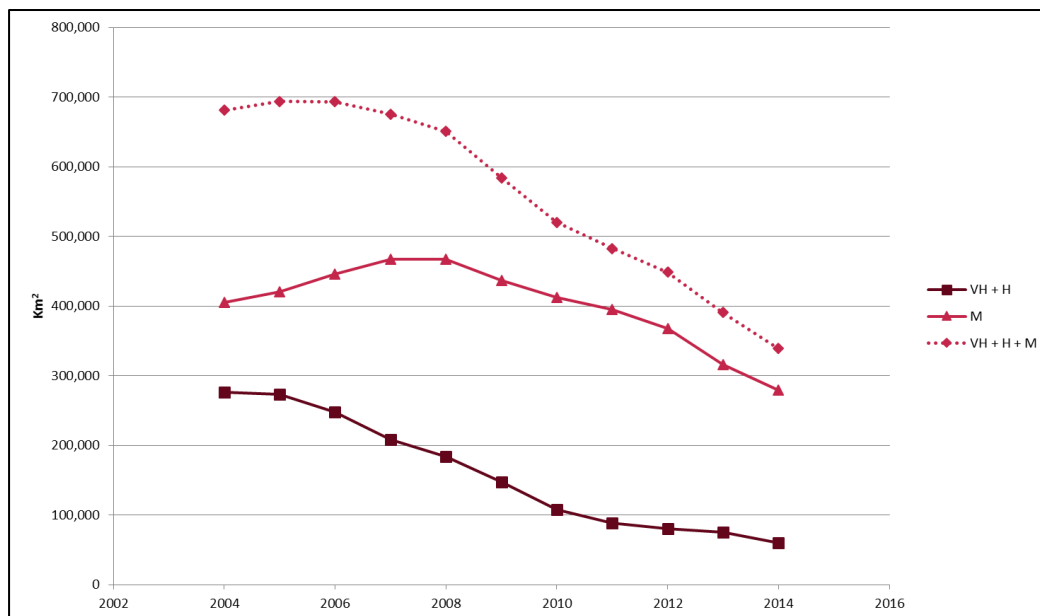

Figure 6. Trends in areas at risk of *Trypanosoma brucei gambiense* infection during the past decade; the values per year express the mean calculated over a 5-year window ending on that year

Remarks

- In the past 2 years, substantive progress towards the goal of elimination of gambiense HAT as a public health problem is evident.
- For the sustainability of elimination, innovative strategies are being adapted to the epidemiological changes, and important efforts are being made to integrate gambiense HAT activities in the general health services, but the resources needed are not always available.
- Access to treatment is ensured but the implementation of screening and diagnosis of the population at risk lacks a sustainable support mechanism.
- There remains insufficient ownership by and commitment of national authorities from endemic countries to the elimination objective.

5. Status reports

5.1 Country reports

The heads of gambiense HAT control programmes from endemic countries had convened in the days before the stakeholders meeting for their annual country coordination meeting. At this event, they had shared and discussed the situation by country, had identified weaknesses and gaps, and had worked on a framework plan of action for the 12 months ahead.

Representatives of national HAT programmes presented the situation at the stakeholders meeting, which was summarized in three groups of countries by region, namely: West Africa, Central Africa and the Democratic Republic of the Congo as a standalone country.

5.1.1 West Africa

This group included eight countries: Benin, Burkina Faso, Côte d'Ivoire, Guinea, Ghana, Mali, Nigeria and Togo (Figure 7). Countries not carrying out any HAT surveillance activities include Guinea-Bissau and Liberia. Occasional assessment activities have been performed in Senegal and Sierra Leone.

Benin, Mali, Niger and Togo have set up passive surveillance in historical transmission areas where no cases were reported for decades. Despite this surveillance no cases have been detected. Passive surveillance was also set up in Burkina Faso and Ghana; these countries reported one case each in 2013 and 2015 respectively.

Guinea has the biggest HAT burden in this group, and therefore leads the trend in the region. The number of reported cases has decreased in the past 2 years; of note is that the Ebola virus disease epidemic forced the complete interruption of HAT surveillance and control in Guinea and impeded access to diagnosis and treatment. Côte d'Ivoire continues to report a low number of cases even if active and passive case-finding has been reinforced including assessment of historical transmission areas. In Nigeria, cases are occasionally reported despite limited surveillance activities, which have been increased in the past year. Civil unrest compromises and/or complicates surveillance and control of gambiense HAT in some areas of the West Africa region.

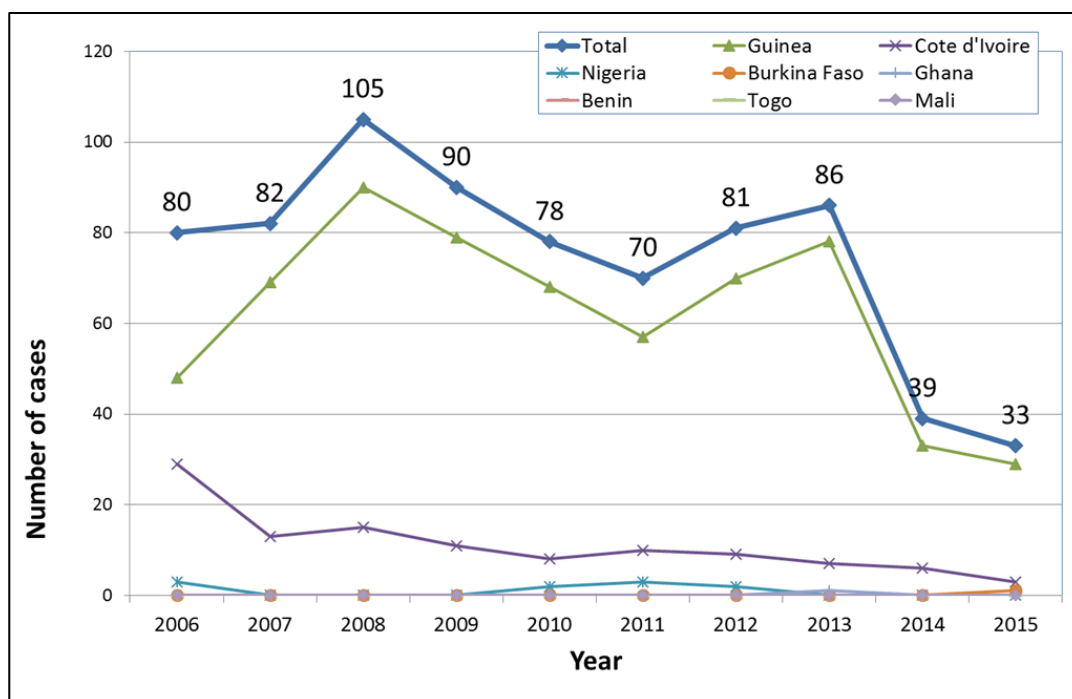

Figure 7. Number of gambiense HAT cases declared in the West Africa region, by countries, 2006–2015

The working group of West African countries agreed on the following priorities:

- Maintain and support capacity for active screening in Côte d'Ivoire and Guinea.
- Consolidate passive screening in countries where it is already in place, and extend it to those not yet performing passive surveillance.
- Assess areas of historical transmission where no updated information is available.
- Ensure reactive active screening of areas where cases were detected by passive surveillance.
- Continue to ensure treatment of all cases.
- Improve coordination and collaboration with partners.
- Extend vector control activities.

The countries in West Africa region requested WHO to:

- continue technical support;
- assist in resource mobilization, including measures to avoid demotivation of technical staff;
- advocate government ownership, including measures to adequately integrate surveillance of gambiense HAT in the general health system;
- ensure coordination of partners involved in the control and elimination of gambiense HAT;
- develop and provide countries with the tools to validate and verify elimination; and
- support countries in the process of validation and verification of elimination.

5.1.2 Central Africa

This group comprised nine countries: Angola, Cameroon, Central African Republic, Chad, Congo, Equatorial Guinea, Gabon, South Sudan and Uganda (Figure 8).

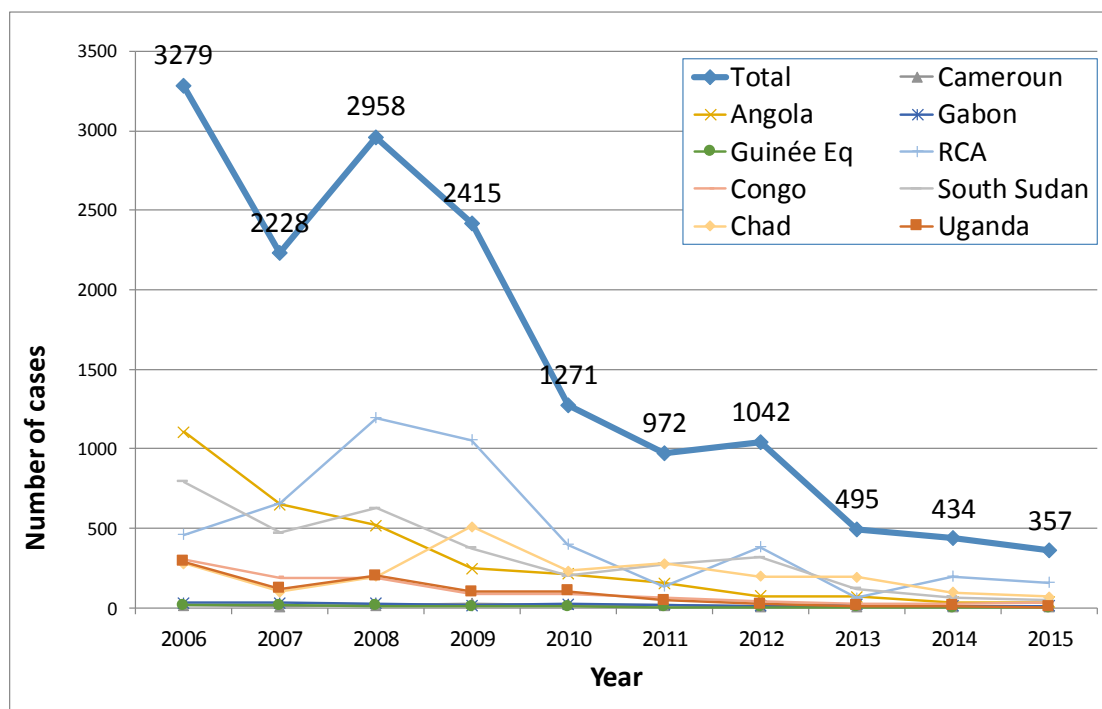

Figure 8. Numbers of gambiense HAT cases declared by countries in the Central Africa region, 2006–2015

Active screening activities are routinely carried out but have been reduced in some countries (Angola, South Sudan); the system of passive case detection has been reinforced in most countries (Cameroon, Chad, Congo, Equatorial Guinea, Gabon and Uganda). Overall, the numbers of cases in this region have decreased significantly from 3279 cases in 2006 to 357 cases in 2015.

This decreasing trend is seen in all the countries of the region. However, in the Central African Republic it must be interpreted carefully as active screening activities are erratic and even stopped in the Haut Mbomou and Ouham prefectures due to security constraints. The same applies for South Sudan where capacities for case detection have deteriorated.

The priorities of this group of countries fell into two categories.

A. Strategic priorities

- Establish or strengthen passive surveillance.
- Maintain active detection and strengthen the capacity of mobile teams.
- Increase or develop targeted vector control activities.
- Increase the number of sites with capacity for HAT diagnosis and treatment.
- Develop alternative, efficient strategies more suited to the epidemiological context.
- Coordinate and strengthen cross-border activities against HAT, develop activities in “blind spots” and intensify activities in “hot spots”.

B. Operational priorities

- Provide control programmes with adequate logistic means including transportation and technical equipment; note that many of those means are becoming obsolete.
- Strengthen human resources responsible for HAT control and surveillance in number and in capacity.
- Ensure a timely supply of laboratory reagents (card agglutination test for trypanosomiasis [CATT], rapid diagnostic tests [RDTs]), mini anion exchange column tests (mAECT), consumables, medicines and vector control tools.
- Obtain technical support for vector control.
- Sensitize and motivate health personnel.
- Raise awareness at all levels, especially at the community level, to ensure participation as the numbers of new cases decrease.

The expectations of these countries regarding WHO support are to:

- advocate with partners to provide additional financial and material support;
- advocate with governments to increase appropriation of the HAT programme;
- develop and implement the tools and criteria for elimination of HAT;
- accompany endemic countries in the elimination process;
- organize coordination meetings of endemic countries;
- continue coaching, technical and financial support to endemic countries; and
- keep a supply of reagents for screening and diagnosis as well as medicines for treatment.

5.1.3 *Democratic Republic of the Congo*

The endemic country with the highest number of cases, the Democratic Republic of the Congo reported 83% of all HAT cases in 2015 alone (2347/2811). However, the number of reported cases is decreasing considerably, from 8023 to 2347 between 2006 and 2015 (Figure 9). The level of surveillance is maintained and even reinforced in some areas.

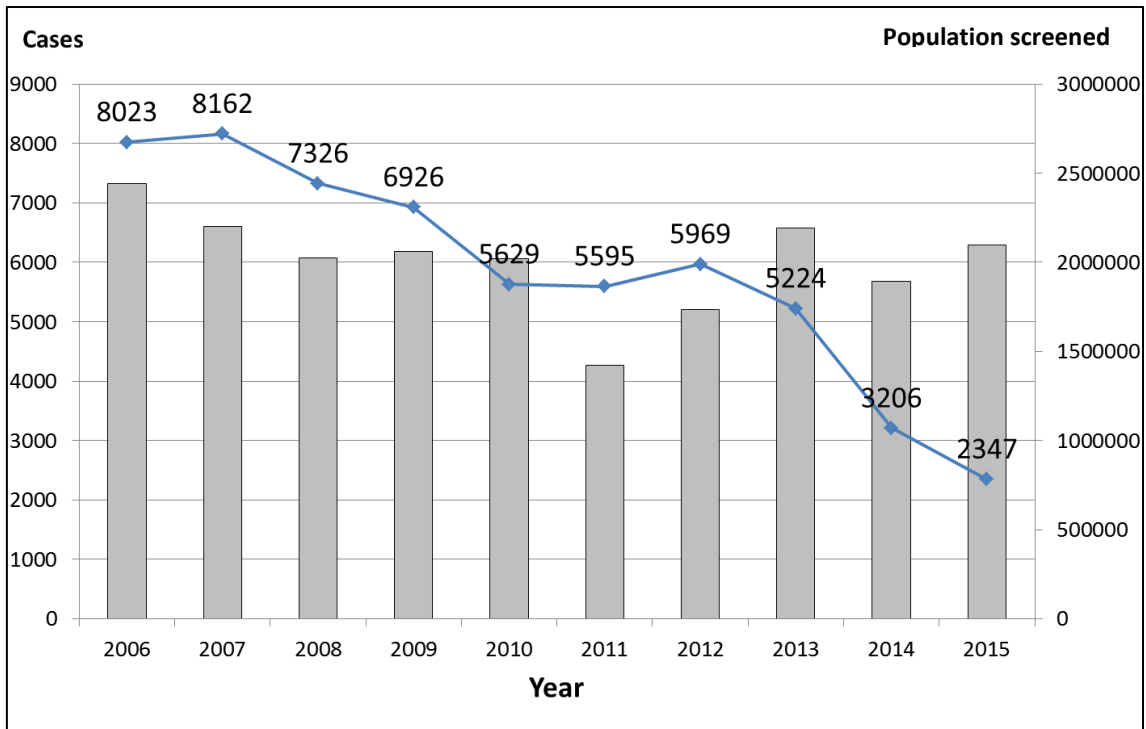

Figure 9. Numbers of HAT cases reported and population screened by year in the Democratic Republic of the Congo, 2006–2015

The national programme (PNLTHA) reports difficulties related to insufficient funding, resulting in insufficient coverage of the population at risk.

Priorities depend on the epidemiological situation per geographical area and on the tools available.

- Increase the population covered (active and passive screening).
- Ensure quality control in active and passive screening.
- Identify the best screening and diagnostic algorithm adapted to different epidemiological situations, including measures to increase the participation of the population in screening activities in low risk areas and the use of mini-mobile teams.
- Identify and implement alternative monitoring strategies in areas of very low prevalence (xenomonitoring, filter papers, sentinel sites).
- Improve knowledge of disease transmission in areas insufficiently covered.
- Increase support to vector control activities.
- Sensitize and motivate partners to continue supporting the objectives of HAT elimination.
- Advocate for policy-makers in the Democratic Republic of the Congo to keep elimination of HAT as a priority.
- Increase the number of provincial coordination teams.

The expectations of the Democratic Republic of the Congo regarding WHO support are to:

- advocate with relevant authorities and partners;
- provide technical assistance;

- support the database (HAT Atlas);
- initiate and advise on the validation process of the elimination of HAT (at provincial and country levels); and
- maintain or increase the current support to the country.

General comments on country reports

The partners reaffirmed their commitment to achieving the goal of elimination and highlighted issues of importance.

- All partners must continue to work together and be actively prepared for the difficulties ahead.
- The big challenge is sustainability of activities; securing adequate financial resources is critical.
- Resources, including human resources, must be maintained or increased; continuous education and capacity building is important and was requested by the endemic countries.
- It is important to promote the ownership and commitment of national leadership to HAT control and elimination.
- The development of new, more performant tools for the diagnosis and treatment of HAT patients remains a necessity, as does the development of strategies to facilitate their implementation.
- New strategies and tools have to be adapted to the low prevalence settings.
- From a public health perspective, all the evidence presented at this meeting should be considered within a framework of integration of HAT activities into national health systems.

5.2 Reports from nongovernmental organizations

5.2.1 Médecins Sans Frontières (MSF)

MSF is active in the field, working on diagnosis, treatment and control in remote, politically unstable areas such as Batangafo in north-west Central African Republic. Between 2007 and 2016, MSF teams screened 132 697 individuals and treated 1649 patients with gambiense HAT.

The MSF international mobile team has worked since 2012 in difficult to access blind spots of the Central African Republic, Congo, Democratic Republic of the Congo and South Sudan. In the Democratic Republic of the Congo the team has screened 29 309 people and treated 111 patients.

Some MSF programmes have served as research sites for studies on new diagnostic tools (pilot implementation of rapid diagnostic tests) and new treatments (fexinidazole).

Activities to advocate and lobby for sustained funding and political support to the HAT elimination goal have been less intense in recent years. HAT control efforts have also decreased as other areas of intervention outside gambiense HAT have received higher priority.

Under the supervision and technical guidance of WHO, MSF-Logistics continues to ensure the important services of conditioning, storage and shipment of antitrypanosomal medicines, including the assembly of nifurtimox–eflornithine combination therapy (NECT) kits.

6. WHO Network for gambiense HAT elimination report 2014–2016

Coordination among stakeholders is becoming crucial as we advance towards elimination. Following the declaration of the first stakeholders’ meeting, the network established under WHO’s leadership (Figure 10) is working to ensure coordinated, strengthened and sustained efforts to eliminate the disease.

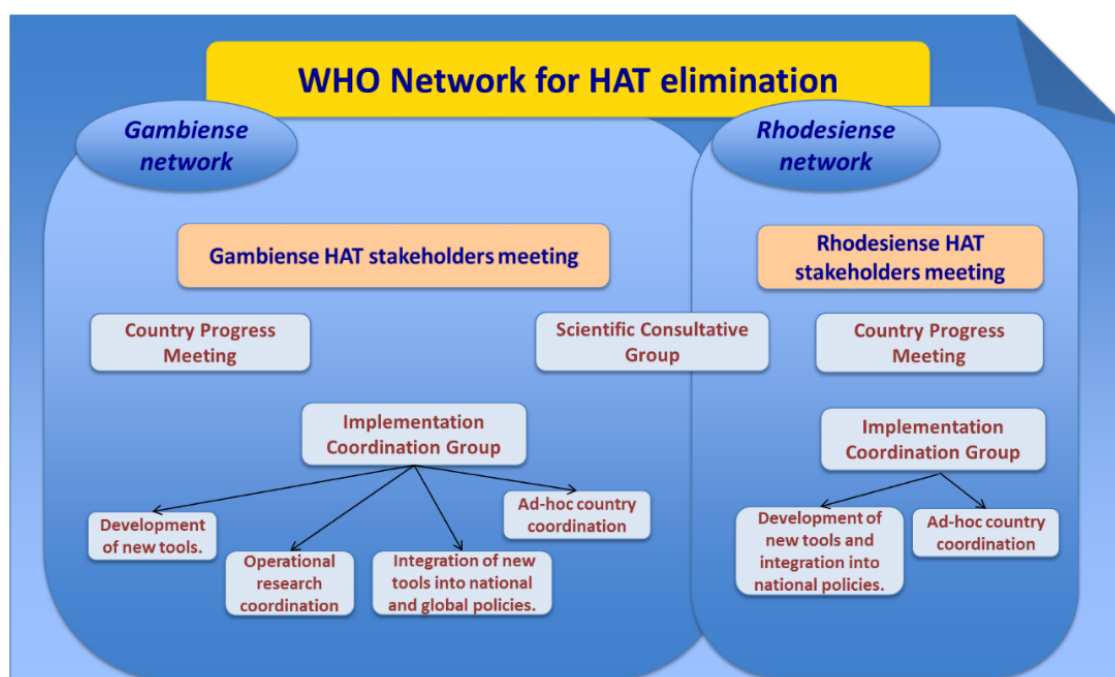

Figure 10. Configuration of the WHO Network for HAT elimination

The first stakeholders meeting (March 2014) had a large participation of sleeping sickness national control programmes, international organizations, donors, foundations, nongovernmental organizations and scientific institutions developing new tools. The gambiense HAT network was set up⁶ and a declaration issued.⁷

Between 2014 and 2016 the different groups and subgroups of the network conducted various activities.

- Country progress meetings involving all endemic countries (Yaoundé, March 2015 and Geneva, March 2016).
- Development of new tools meeting to update the methodological framework for HAT clinical trials (September 2014).

⁶ Report of the first WHO stakeholders meeting on gambiense human African trypanosomiasis. Geneva, 25–27 March 2014. Geneva: World Health Organization; 2014 (http://apps.who.int/iris/bitstream/10665/147021/1/9789241508070_eng.pdf?ua=1).

⁷ Holmes P. First WHO meeting of stakeholders on elimination of gambiense human African trypanosomiasis. PLoS Negl Trop Dis. 2014 Oct; 8(10):e3244.

- Integration of new tools into national and global policies through several subgroup activities:
 - first meeting, to agree next steps after the phase III clinical trial of the new oral drug, fexinidazole (December 2014);
 - second meeting, to advance HAT diagnostics (15 May 2015);
 - third meeting, to follow up on new oral drugs for HAT (15 June 2015); and
 - fourth meeting, to follow up on new oral drugs for HAT (7 December 2015);

Two new thematic subgroups have been proposed: vector control and socio-anthropology.

- Ad hoc country coordination
 - Democratic Republic of the Congo: six PNLTHA partners' meetings (Geneva, Antwerp and Kinshasa, 2014–2016).
 - Côte d'Ivoire: workshop for the creation of a research and control network on trypanosomiasis and tsetse organized by IRD and PNETHA (February 2015).
 - Uganda: meeting on trypanosomiasis and tsetse partners' harmonization organized by WHO and (inter-ministerial body) COCTU (March 2015).
 - Benin and Togo: workshop to assess and plan surveillance in historical foci (December 2015); two previous workshops (Cotonou, July 2012 and Lomé, July 2013).
- The Scientific Consultative Group will include the Technical Advisory Group for HAT elimination (HAT-e-TAG). This group, which is being constituted and should become active in 2016, will establish the criteria and procedures to assess HAT elimination.

Remarks

The network has conducted multiple activities involving all the different technical groups, SSNCPs, and partners involved in gambiense HAT elimination. WHO will continue to follow this strategy of collaborative discussion and development of new strategies to overcome the anticipated obstacles. The creation of new subgroups in the technical areas of vector control and socio-anthropology could further facilitate synergy and bring new perspectives to the global understanding of gambiense HAT, and, consequently, make a very positive contribution to its elimination.

7. Control and surveillance: the state of the art and challenges

7.1 Screening and diagnosis

There have been no major advances in the area of screening and diagnostic tools and their implementation in the field since the last meeting. The screening tests (CATT and first-generation RDTs) use native antigens; the second generation RDTs use recombinant antigens (in prototype stage, under evaluation). First-generation RDTs are available as cassette tests. The second-generation RDTs will be available in strips or multiple cassette tests, making transport of the tests more practical. Alternative recombinant antigens (rLiTat 1.3, rLiTat 1.5, rISG65) expressed in *Leishmania tarentolae*, *Escherichia coli* or baculovirus are used for the new generations of RDTs. Recombinant antigens are easier and cheaper to produce and could be an alternative to the bottleneck that arises from the use of native antigens to produce first-generation tests.

A prototype RDT combining malaria and gambiense HAT is being developed based on existing *Plasmodium falciparum* RDTs and second-generation HAT RDTs. Preliminary results, in stored samples, show identical sensitivity and specificity of the HAT serological tests in isolation or combined with malaria. However, some discussion is needed on the foreseeable use of combined diagnosis for different diseases, as there is no consensus on that subject. Another interesting possibility is to combine different HAT serological tests striking the best balance between sensitivity and specificity. Preliminary work in the Democratic Republic of the Congo shows promising results.

For parasitological confirmation, the field tests are still lymph node aspiration, centrifugation in capillary tubes (CTC) and mini anion exchange column test (mAECT) in the blood, and modified single centrifugation (MSC) of cerebrospinal fluid (CSF). Some practical advances for mAECT and MSC have been achieved by the Institute of Tropical Medicine of Antwerp: new adaptations have provided easier readings by the collector tube to fit 20x and 40x objectives. Prices of the mAECT test are expected to decrease by 40%, as a result of the partnership with and donation of raw material by GE Healthcare through WHO. Raised production of mAECT tests is also expected. Ongoing research by FIND on different observation (LED fluorescence microscopy) and staining (acridine orange in CTC) techniques has yielded preliminary results.

Immune trypanolysis, a reference serological test with high specificity, still requires a sophisticated laboratory setting to be executed, and is available in only three centres worldwide (ITM, CIRDES, INRB).

The molecular tools for diagnosis have not made any important, practical, field-use progress: 18S/TBR PCR or Q-PCR, as well as SL-RNA tests, need a specifically equipped laboratory, RIME LAMP is difficult to use in the field and TasGP/PCR LAMP is not sufficiently sensitive. All these tools are also expensive. A FIND phase II clinical evaluation on the HAT LAMP kit took place in the Democratic Republic of the Congo (2014–2015): LAMP was performed on buffy coat (in comparison to LAMP on whole blood), fresh or on filter paper, to improve sensitivity; data cleaning and analysis are still in progress.

Algorithms play an important role in diagnostic decision-making. Different algorithms are used and adapted to the epidemiological situation and to the capacities in each focus (Figure 11).

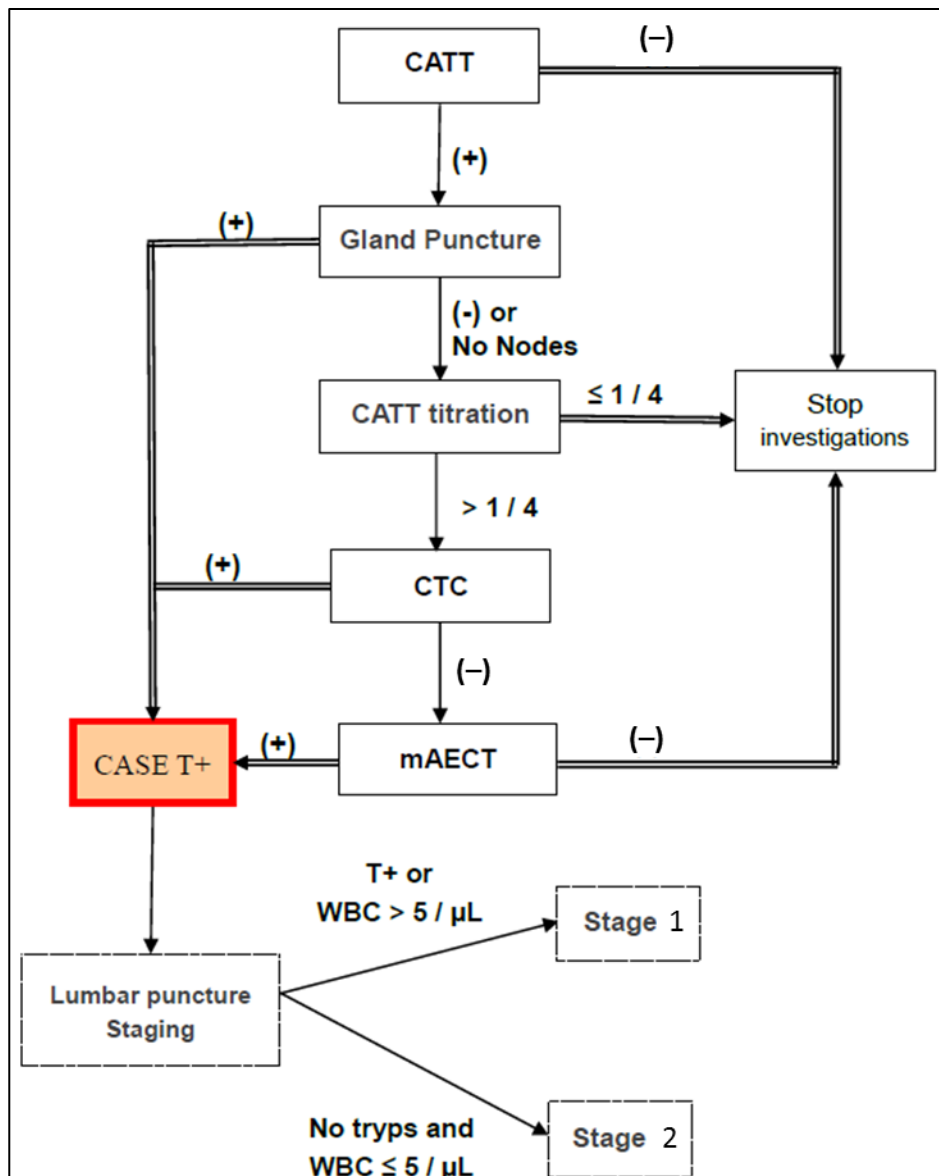

CATT, card agglutination test for trypanosomiasis; CTC, capillary tube centrifugation; mAECT, mini anion exchange column test; WBC, white blood-cell count

Figure 11. Algorithm frequently used for active screening If negative CATT, release the person; if positive CATT, search for enlarged lymph nodes and, if present, conduct gland puncture and microscopy examination of lymph node fluid. If parasites are seen it is a HAT case. If no lymph nodes or negative lymph nodes, advance to CATT dilution: if negative dilution beyond 1/4, release the person; if positive dilution beyond 1/4, advance to CTC. If positive, it is a case of HAT. If not, proceed to mAECT. If mAECT is positive, it is a case of HAT; if not, release the person

Ideally, a suitable oral treatment effective against both stages, plus suitable serological RDTs with higher sensitivity and specificity, could lead to a much simpler algorithm: a clinical suspect would be tested with a single RDT and, if positive, could be treated with an oral medication that cures both stages of the disease (Figure 12). However, for the time being, parasitological confirmation remains essential.

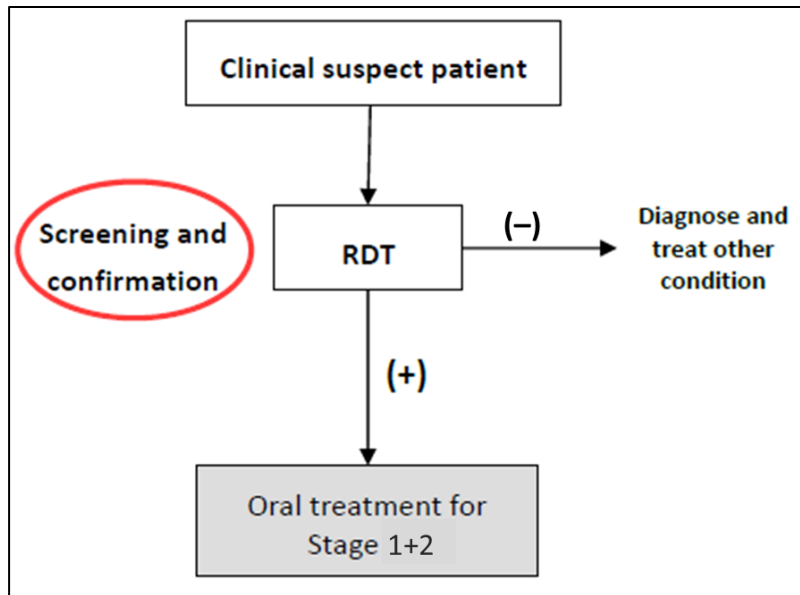

Figure 12. Ideal hypothetical situation with an effective, safe and simple oral medicine, and highly specific and sensitive serological rapid diagnostic tests

An intermediate algorithm between the current algorithm and the ideal algorithm is already implemented in some centres treating gambiense HAT patients. These centres use CATT or RDTs to screen clinical suspects who, if tested positive, undergo parasitological tests; if positive the patient is staged with CSF examination and prescribed stage-specific treatment. This algorithm (Figure 13) is more suitable for passive screening in low transmission settings where individual serological tests are performed on selected patients who present with a clinical picture compatible with HAT.

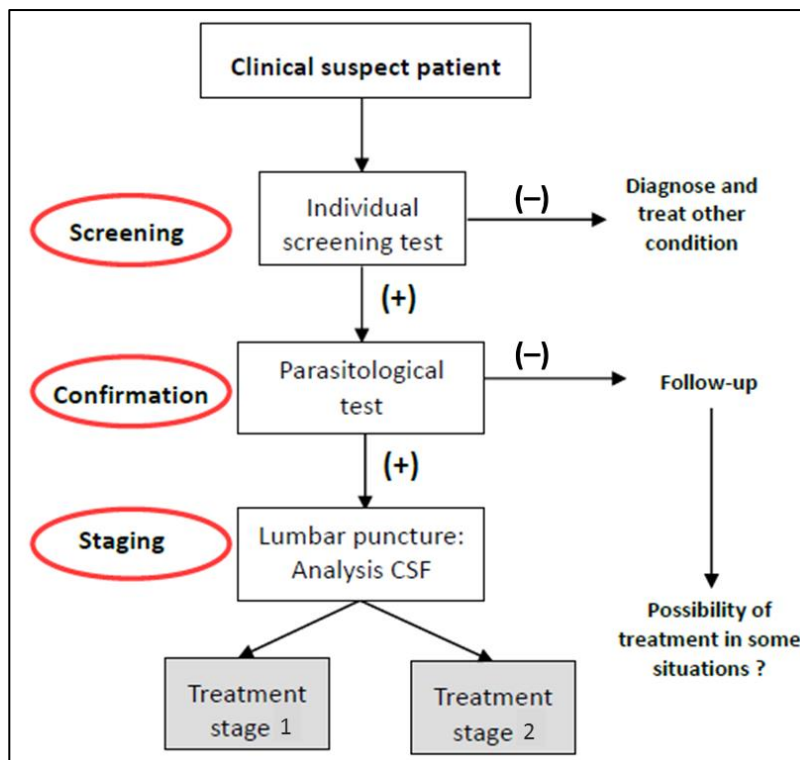

Figure 13. Diagnosis and treatment: current situation with available tools

Diagnostic Tools for Human African Trypanosomiasis Elimination and Clinical Trials (DiTECT-HAT) is an IRD-led project funded by a European Union grant. The project, a translational, field-based independent evaluation of the tools used to diagnose and treat gambiense HAT, will assess the feasibility and adaptation of ready-to-use new tools, and propose algorithms for the diagnosis of gambiense HAT in three main contexts:

1. Passive screening in peripheral health centres
2. Post-elimination monitoring to detect the re-emergence of the disease
3. Early test-of-cure in clinical trials

Remarks on screening and diagnosis of gambiense HAT

- Parasitological confirmation of serologically suspected individuals remains essential.
- Guidance on clinical management of unconfirmed serological suspects is needed.
- The capacities of staff for screening and diagnosis need to be enhanced and quality control ensured.
- The manuals on screening and diagnostic tests need to be periodically updated.
- An assessment of challenges towards implementation of RDTs is needed.
- An independent evaluation of new tools is necessary; the DiTECT-HAT project could play a role.
- Research on test of cure (preferably in blood) will be helpful, mainly in the context of clinical trials.
- A better forecast of the needs of tests would facilitate their commercial production.
- Implementation of the best and most adequate diagnostic methods must be supported; it would be helpful to create an advocacy narrative on access to diagnostics as has been done for access to HAT medicines.

7.2 Treatment

For the past 15 years the best available treatments have been administered timely to all HAT cases detected in endemic countries. With the only exception of Burkina Faso, all countries where gambiense HAT is routinely diagnosed have the capacity to treat patients with NECT. There were no major changes in the production and distribution of existing HAT medicines and in the donation agreements between Sanofi (for eflornithine, melarsoprol and pentamidine), Bayer (for suramin and nifurtimox) and WHO. Extensions of these agreements have been guaranteed for the next 5 years. WHO monitors the needs for medicines per country and produces regular forecasts which are used to plan the production directly with the manufacturers (Sanofi and Bayer). This mechanism ensures timely availability of all needed treatments while minimizing wastage.

All the logistics related to storage, assembly of kits and international shipment are ensured by MSF-Logistique under a contract with WHO. The importation and distribution of medicines up to the end user are facilitated by WHO according to the needs per country. The medicines for stage 2 gambiense HAT, which require intravenous infusion, are distributed in kits; all the materials needed for their administration are included. WHO provides practical training to health personnel responsible for treatment at national, regional and local levels.

WHO also supplies all the medicines for treating exported HAT cases in non-endemic countries, and provides technical support as needed.

Research on novel treatment has focused on the development of a new oral medicine effective for the treatment of both stage 1 and stage 2 *Trypanosoma brucei gambiense* infection, and also for *T. b. rhodesiense*.

7.2.1 Fexinidazole

Initial studies of fexinidazole, an oral nitroimidazole, have been conducted in areas endemic for gambiense HAT.

Different clinical trials have been planned for this medicine, some of which have completed the recruitment phase in the field; data on treatment follow-up are still being collected and analysed. The established dosage for treatment with fexinidazole is a single daily dose, taken with food:

- Adults and children aged > 6 years and ≥ 35 kg body weight: 3 tablets of 600 mg (days 1–4) followed by 2 tablets of 600 mg (days 5–10).
- Children aged > 6 years and 20–34 kg body weight: 2 tablets of 600 mg (days 1–4) followed by 1 tablet of 600 mg (days 5–10).

Three fexinidazole studies are ongoing (Figure 14).

- **Study FEX004** A phase II/III pivotal randomised clinical trial comparing fexinidazole versus NECT in adults with gambiense HAT stage 2; the fexinidazole regimen consisted of a single daily dose given with food during 10 days. Recruitment started in November 2012, and ended in the first week of April 2015. The study included 394 patients; follow up is expected to end in October 2016 (primary end-point).
- **Study FEX005** A case-series (no control group) open labelled study of fexinidazole, given in the same regimen as in FEX004 to adults, with gambiense HAT stage 1 (CSF WBC count ≤ 5) and intermediate stage (CSF WBC count 6–20). The study included 230 patients until March 2016; follow up will end in September 2017.
- **Study FEX006** A case-series (no control group) study of fexinidazole in children aged > 6 years and > 20 kg body weight, with gambiense HAT stage 1 and stage 2. The sample size required is 125 patients, already completed; the end of follow-up is expected in June 2017.

Blister packaging to enhance adherence to fexinidazole treatment is under development. Several factors and issues to be considered for the packaging design are under evaluation.

- There will be distinct packaging for adult and paediatric formulations.
- Treatment is administered in two phases.
- The medication needs to be taken with the main meal.
- There is a risk of misadministration.
- Treatment will be supervised or administered under direct observation (DOT).

A new study – Fex009 or study phase IIIb – is an open-label, multicentre cohort study assessing the effectiveness and safety of fexinidazole in adults and children. Some patients are being hospitalized to receive treatment and food under direct observation while some are being given fexinidazole to take home, as outpatients, without food being provided. This

study will be combined with DiTECT-HAT to include an assessment of new tests aimed at establishing the treatment outcome earlier. The main objectives are:

- to assess the tolerability and effectiveness of fexinidazole administered to inpatients and outpatients in both disease stages;
- to evaluate the feasibility and effectiveness of fexinidazole in outpatients;
- to measure patients' compliance with treatment;
- to evaluate the acceptability of final packaging;
- to evaluate safety in a wider study population;
- to assess new tests of treatment outcome via the DiTECT-HAT study by
 - detection of SL-RNA in blood
 - detection of SL-RNA in CSF
 - quantification of neopterin in CSF.

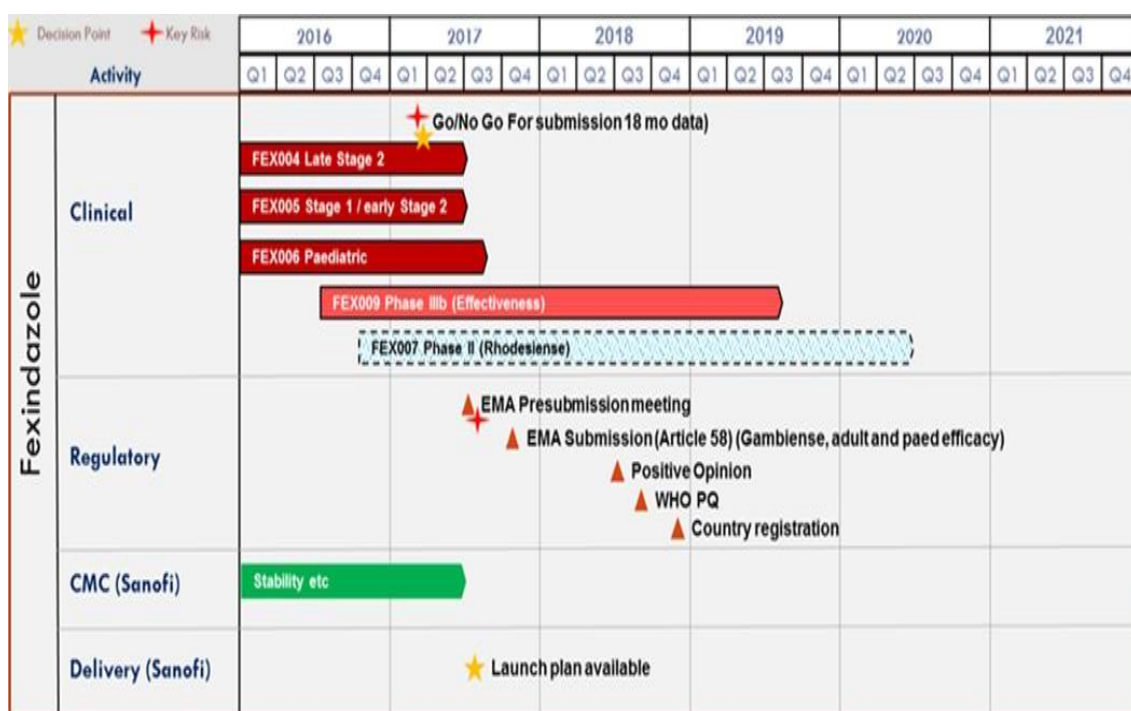

Figure 14. HAT clinical programme high-level schedule for fexinidazole

The effect of food on fexinidazole absorption is problematic, and different approaches could be considered to ensure food intake.

- Keep the patient hospitalized and provide food.
- Keep the patient hospitalized and ask the family to provide food.
- Send the patient back home after explaining the importance of taking the medicine with food.
- Provide fexinidazole and food in the same kit.

These issues are not only about efficacy and resistance but also about ethical aspects related to the fatal nature of HAT plus the risk to the community.

For the registration of fexinidazole, Sanofi will submit the package of results to the European Medicines Agency under the “Article 58 pathway”, a novel approach in cooperation with WHO, which does not provide a market authorization but a *scientific opinion* intended for markets outside the European Union. This scientific opinion is expected in mid-2018; assuming that it is positive, the strategy is then to request prequalification from WHO and to submit afterwards the product for registration in endemic countries. The process of registration in countries would then take place in the fourth quarter of 2018.

7.2.2 Oxaborole SCYX-7158

SCYX-7158 is the first oxaborole-based oral drug candidate for the treatment of gambiense HAT. It is administered as a single oral dose, with indication for both disease stages. Preliminary safety data have been obtained in phase I studies, where the only serious adverse event observed was asymptomatic increase of thyroid function test (3 months after dosing), transient, of mild intensity and spontaneously resolved.

Study protocol OXA02 (Figure 15) is a phase II/III, open-label, multicentre trial assessing efficacy and safety in adults with stage 2 gambiense HAT. The assessment will compare SCYX-7158 with NECT historical controls. A futility analysis is planned after 20 patients. Stage 1 patients will be added after the first futility analysis. A single dose of 960 mg will be the dosage tested.

This study also includes the assessment of new tests for treatment outcome (DiTECT HAT of IRD and partners).

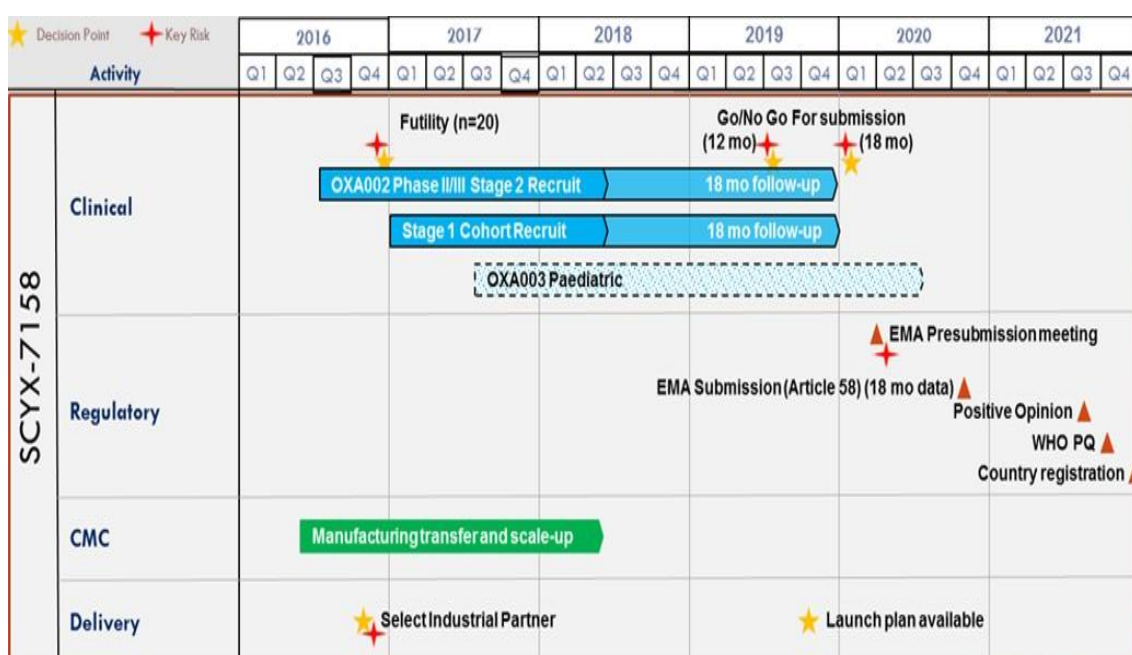

Figure 15. HAT clinical programme high-level schedule for oxaborole

After NECT, fexinidazole and SCYX-7158 should bring major incremental benefits to the treatment of gambiense HAT. **Fexinidazole** could become a breakthrough, stage-independent oral treatment although with the inconvenience of a 10-day schedule, the need for some level of observed treatment and the requirement for concomitant food intake. **SCYX-7158** could represent a treatment tool for sustained elimination, treating both disease stages with a single oral dose (thus, no compliance issues) and for use in politically unstable regions or

very remote areas. Combined with a field-adapted diagnostic tool, it could transform HAT into an easily manageable disease.

Remarks on fexinidazole and SCYX-7158 clinical trials

Fexinidazole

- The research is progressing well in accordance with the timeframe.
- The bioequivalence of the formulation used in the clinical trials and the commercially available formulation was shown to be good.
- Very good work is being accomplished on presentation and packaging, and progress is ongoing.
- The sites for the phase IIIb study should be those already familiar with fexinidazole via the current study.
- Use in “real-life” should be documented later in a phase IV study and include health facilities that are more peripheral.

SCYX-7158

- Studies of pharmacokinetics and therapeutic dosage are completed.
- Recruitment is planned to start in mid-2016

General remarks

The direct and indirect as well as positive and negative impacts of clinical trials on HAT control activities should be each time evaluated to avoid diverting or weakening the resources available for control and/or the situations that could generate gaps when the clinical trial programme is withdrawn.

7.3 Epidemiological tools

7.3.1 New approaches for case detection

Current interventions to eliminate gambiense HAT are based on active case detection using mobile teams, and passive case detection. Sentinel sites are equipped with RDTs and their staff trained to follow clinical algorithms that prompt testing of patients. They follow a referral chain for further investigation of positive serology and eventual confirmation of infection. Vector control is deployed in selected sites depending on resources and epidemiological knowledge. Based on this strategy different new approaches have been adapted to different situations.

Extending the integrated reactive surveillance system: sentinel sites

WHO is working **to extend the integrated passive surveillance system in sentinel sites** as areas of high transmission are reduced and active screening in low transmission areas loses its effectivity. This surveillance system is based on the integration of screening, diagnosis and treatment of gambiense HAT in general health services and is implemented in selected, well identified fixed health facilities (sentinel sites) (Figure 16).

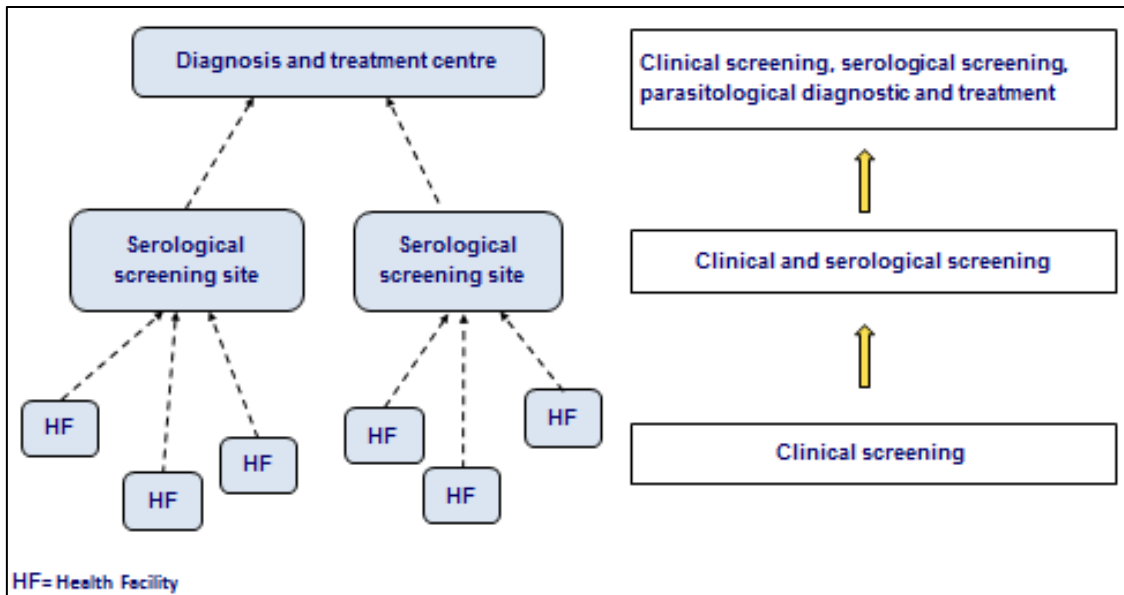

Figure 16. The different levels of the integrated surveillance system

This passive surveillance system has been introduced in Benin, Burkina Faso, Cameroon, Chad, Congo, Côte d’Ivoire, Democratic Republic of the Congo (Equateur Nord), Equatorial Guinea, Gabon, Ghana, Guinea, Mali, Niger and Togo.

Rationalizing active case-finding efforts

The **“HAT case project”** (led by ITM and PNLTHA-RDC) addressed the adaptation of gambiense HAT active case-finding to epidemiological status using light mobile teams. This study involved door-to-door screening by an individual health worker travelling on a motorcycle, accompanied by a local village health worker. RDT or CATT was performed as a screening test, a filter paper sample taken if the serological test was positive (+ 1 negative control), and a personal digital assistant (PDA) was used to collect all data in digital format including photographs of positive results. All these procedures were done at the village level. In a district/provincial laboratory all filter paper samples were examined by LAMP (whole blood + buffy coat) and LAMP-positive samples were revisited and referred for diagnostic confirmation (parasitology). Quality was assured by the photographs of positive results and the negative controls; immune trypanolysis was done on all filter papers.

The preliminary results, referred to the initial phase of the project, indicate that the project was well accepted by the population, and there were no major technical problems. The median population screened daily was 70–80 people. The project was run successively in Beno and Mbaye Laramé (Bandundu, Democratic Republic of the Congo), adapting progressively the methodology, introducing comparison CATT-RDT, video confirmation of parasitological-positive tests and diagnostic confirmation on the spot by the laboratory technician on a motorcycle, within a 1-week delay.

Main remarks

- The cost per person screened cannot be substantially reduced by light mobile teams; however, coverage is improved.
- The use of a PDA allows GIS coordinates and photographs/videos to be registered for quality control; the device is useful not only for mini teams but also for classic mobile teams.
- The use of GIS can improve planning of screening; the system is most effective if a complete list of villages with coordinates and population estimates is available.
- Mobile teams and mini teams can work in parallel: a mobile team in a large village (and/or large areas with easy access) and mini teams in small villages (or small areas with difficult access).

Intensifying surveillance for passive case-finding

The Foundation for Innovative New Diagnostics (FIND) has been working on **novel strategies to intensify passive surveillance**, involving all health facilities in some endemic areas in 8 of the 11 countries that reported cases of gambiense HAT in 2014 (Angola, Chad, Congo, Democratic Republic of the Congo, Guinea, Nigeria, South Sudan and Uganda).

In Uganda, intensified passive screening for gambiense HAT started in 2013: some 200 centres perform HAT RDT, 9 centres perform RDT and microscopy, and 3 centres perform RDT, microscopy and LAMP. In 2013 and 2014, a total of 9 cases per year were detected. In 2015, only 4 cases were detected by passive screening; and in the first three months of 2016, only 2 gambiense HAT cases were detected. The facilities were reduced to 125 in 2014, but increased to 136 in 2015 by including private clinics and facilities in refugee camps; in 2016 they were increased to 149 by including more private clinics. A transition to sentinel surveillance as recommended by WHO (passive screening in fewer, selected sites, with reactive active screening) is planned in 2017.

In Chad (Mandoul focus) in 2015, passive surveillance was implemented in 10 health facilities and active screening was done using one motorcycle mobile team.

In Nigeria (Delta State) in 2014–2015, no gambiense HAT cases were detected.

In the Democratic Republic of the Congo (Kongo Central Province) from July 2015 to January 2016, some 597 health facilities were trained and RDT introduced; since then, 26 cases have been detected. Here, a recurrent and already described problem was observed: a high number of RDT-positive suspects in the absence of the disease. Research is needed to understand if these positive RDTs are a consequence of transient antibody response following the bites of tsetse flies carrying animal parasites or are latent HAT infections.

The challenges raised by this project include the awareness of availability of new tools and the reluctance to change; the low referral rate of RDT-positive suspects for parasitological examinations; the collection and transfer of data; and, on the more technical side, the low sensitivity of parasitological methods and the lack of expertise in reading RDT, parasitology tests and LAMP results.

7.3.2 Improving knowledge

Understanding the roles of animal reservoirs and healthy human carriers in maintaining transmission of gambiense HAT

IRD is studying the role of **resistant individuals** who become **asymptomatic carriers** as well as the role of **animal reservoirs** in the context of gambiense HAT elimination. Preliminary work shows that **asymptomatic human carriers** (CATT \geq 1/8; positive immune trypanolysis test) of *T. b. gambiense* may have distinct cytokine and transcription profiles, and while HAT patients have an immune response dominated by B-cell expansion, it is not so in asymptomatic cases. In addition, leucocyte migration and inflammation mediators are important in determining the susceptibility status. These findings are improving our understanding of symptomatic versus asymptomatic carriage.

The epidemiological role of **animal reservoirs of *T. b. gambiense*** is as yet unclear. However, even if it could have a low impact on the elimination process, it could impair the sustainability of elimination and/or the eradication of the disease. It has been proven that tsetse flies can become infected even from animals with apparent low blood parasitaemia; in the context of gambiense HAT elimination, this should be a good reason to establish and implement domestic animal experimental infection models.

Calculating the coverage of active and passive case-finding

Measurement of the **coverage of the population at risk of gambiense HAT by active and passive screening** is an important epidemiological tool to understand and comprehensively analyse the robustness of results obtained in the fight against gambiense HAT and to plan efforts at all levels.

The methodology used to calculate the **coverage of populations at risk of gambiense HAT by active screening** is similar to that used to estimate the risk of HAT: the numerator is the number of people actively screened, as geo-referenced by the HAT Atlas, and the denominator is the total population, using the Landscan™ estimations. The population at risk is stratified into three risk categories: high–very high, moderate, and low–very low. The intensity surfaces used for the calculation are estimated with “spatial smoothing” via a quadratic kernel function, using a search radius of 30 km.

Approximately 80% of the population screened is mapped at the village level in the HAT Atlas (2008–2012). The remaining 20% is mapped at a higher (coarser) level, e.g. focus, district, province and proportionally allocated to mapped villages of the corresponding area.

The coverage by active screening, calculated over the 5-year period 2008–2012, is shown in Figure 17 and Figure 18. In a preliminary analysis of that period among the population at high and very high risk (estimated at nearly 1.8 million), a mean of 567 065 people (31.9%) were screened actively every year. The annual coverage of the population at moderate and low risk was 7% and 0.6% respectively.

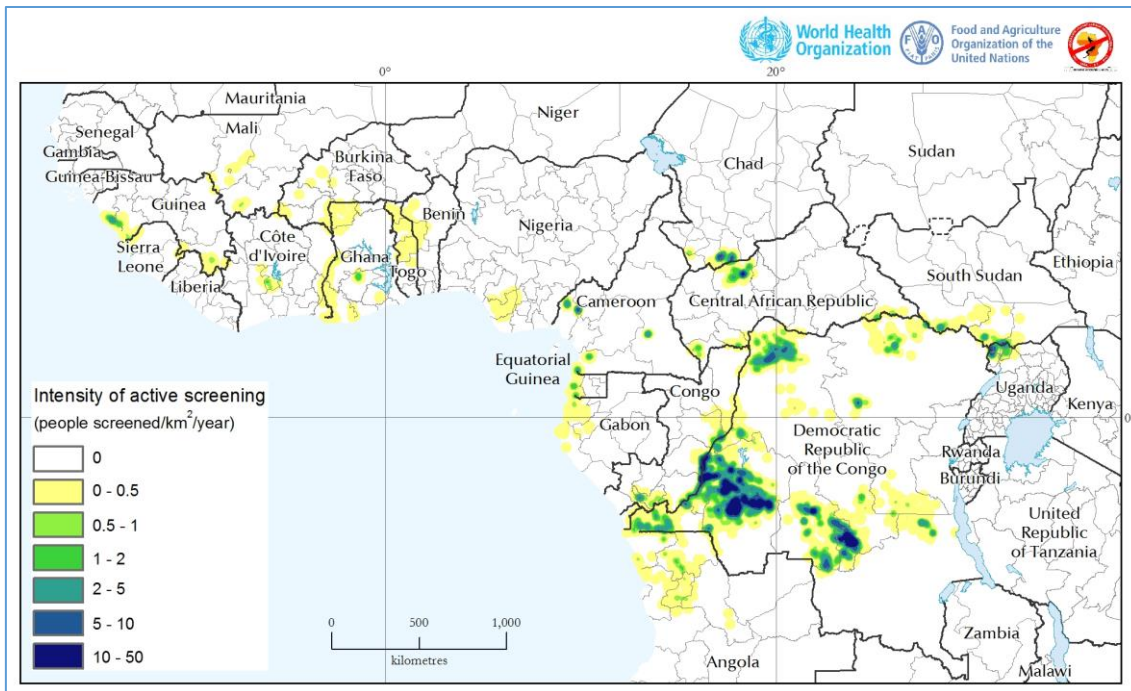

Figure 17. Intensity of active screening for gambiense HAT, 2008–2012

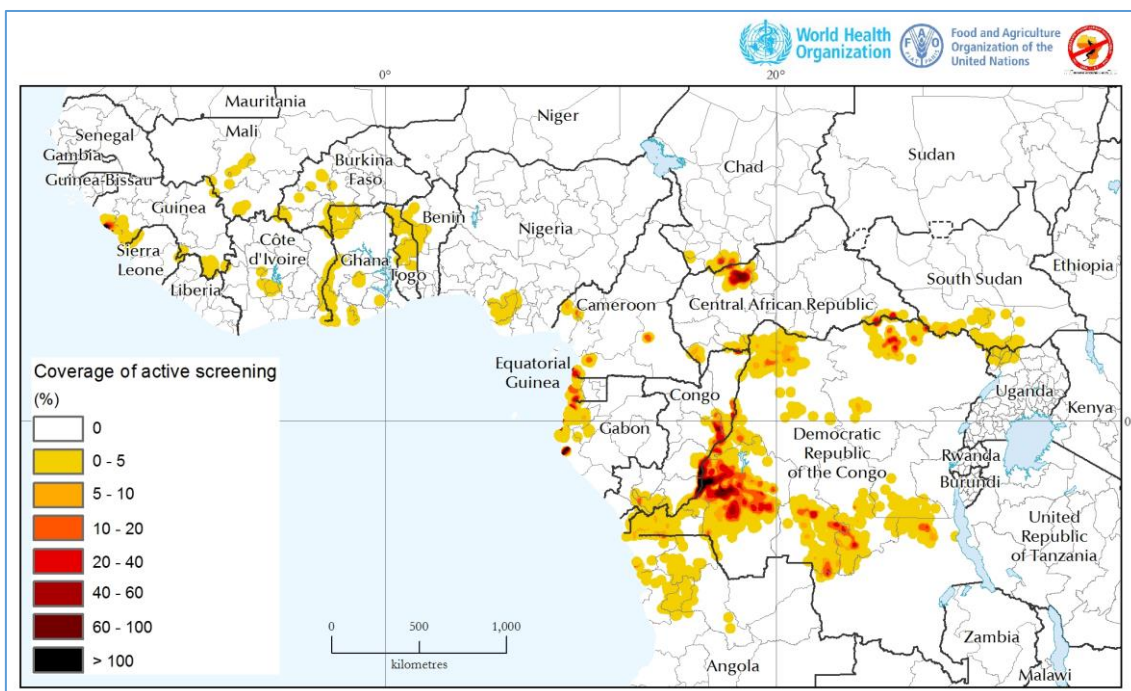

Figure 18. Coverage of active screening for gambiense HAT, 2008–2012

The calculation of the **coverage of the population at risk by passive screening** is based on data reported from all health facilities providing diagnosis and treatment of gambiense HAT. A first survey collected these data in 2013⁸ and a follow-up survey in 2016 updated the information. The total number of health facilities providing diagnosis of gambiense HAT

⁸ Simarro PP, Cecchi G, Franco JR, Paone M, Diarra A, Ruiz-Postigo JA et al. Mapping the capacities of fixed health facilities to cover people at risk of gambiense human African trypanosomiasis. *Int J Health Geogr.* 2014;13:4.

(whether clinical, serological, parasitological or staging) between 2013 and 2016 increased from 622 to 880 and the number of health facilities providing treatment from 495 to 516.

To estimate coverage, all health facilities are mapped and their physical accessibility is measured via time–distance analysis using the available information on roads and other ways for the population to reach them (“friction layers”). The analysis determines, by a geographical function, the shortest distance (or travel time) from any location to a given health facility. This makes it possible to measure the travel time for the population at risk, village by village, to the nearest health facility providing gambiense HAT services. Subsequently, the population living within certain predetermined travel times (i.e. 1, 3 and 5 hours) from a facility offering gambiense HAT services can be computed from a population layer.

The substantial increase in the number of health facilities providing gambiense HAT services has increased the population covered by several millions, notably their access to serological screening and to NECT treatment; these two elements were expanded the most in this time period. Figure 19 shows the variation in the population covered. Figure 20 shows the percentage coverage by risk category. Coverage increased in all services, but decreased for treatment with melarsoprol and eflornithine, which ceased to be offered in most sites and was replaced by NECT.

Diagnosis	Population potentially covered [millions]		
	≤ 1 hour travel	≤ 3 hour travel	≤ 5 hour travel
Diagnosis, any	+21	+46	+50
Diagnosis, clinical	+21	+46	+50
Diagnosis, serology	+16	+49	+68
Diagnosis, parasitology	+5	+11	+14
Diagnosis, staging	+5	+10	+13
Treatment			
Treatment, any	+9	+16	+20
Treatment, pentamidine	+9	+16	+20
Treatment, melarsoprol	-2	-19	-51
Treatment, eflornithine	+1	+3	+6
Treatment, NECT	+10	+26	+48

Figure 19. Variation of population potentially covered by health facilities providing gambiense HAT services, by travel time to the nearest facility and risk category, 2013 to 2016 (preliminary results)

Type of diagnosis	At-risk population potentially covered [%]									
	≤ 1 hour travel time			≤ 3 hour travel time			≤ 5 hour travel time			
	VH-H	M	L-VL	VH-H	M	L-VL	VH-H	M	L-VL	
Any diagnosis	45	43	53	83	75	78	92	88	88	↑
Clinical	45	43	52	83	75	77	92	88	88	↑
Serology	39	38	50	79	71	71	91	86	86	↑
Parasitology	36	34	44	78	69	71	90	85	84	↑
Staging	36	34	42	78	69	71	90	85	84	↑

Treatment	At-risk population potentially covered [%]									
	≤ 1 hour travel time			≤ 3 hour travel time			≤ 5 hour travel time			
	VH-H	M	L-VL	VH-H	M	L-VL	VH-H	M	L-VL	
Any treatment	44	41	42	83	73	73	92	87	85	↑
Pentamidine	44	41	42	83	73	73	92	87	85	↑
Melarsoprol	22	28	29	49	58	55	62	73	67	↓
Eflornithine	22	29	37	48	60	65	61	76	76	↓
NECT	35	32	39	77	68	70	89	84	83	↑

VH-H= very high and high risk; M= moderate risk; L-VL= low and very low risk

Figure 20. Percentage coverage of the population at risk of gambiense HAT, by travel time to the nearest health facility, by gambiense HAT services and by risk category, 2016; the arrows represent the variation since 2013 (preliminary results)

Remarks on the work done to improve epidemiological knowledge

- New findings are shedding some light into the phenomenon of asymptomatic human carriers and of animal reservoirs of gambiense HAT, but the knowledge gaps are still important and limit our understanding of their epidemiological role. These aspects are growing in importance in the context of HAT elimination.
- Quantitative methods are being developed that allow for standardized monitoring of coverage of populations at risk of HAT, by active and passive surveillance activities. The coverage has improved substantially in the past 3 years. Diagnosis is currently available in 880 fixed health facilities (+248 in the past 3 years), which cover 45–92% (at 1 or 5 hours travel time respectively) of the population at high risk. Fixed health facilities are called to play an increasingly important role in the elimination process. Active screening remained at a sustained level during the same period. The coverage was estimated for the first time in a preliminary analysis, showing that 31.9% of the population at high and very high risk were screened actively every year.

7.3.3 Attempts to estimate the unknown (modelling)

Modelling may be a useful tool in foreseeing gambiense HAT epidemiological situations and helping in finding solutions. Several research groups presented the results of modelling studies focused on geo-spatial distribution, transmission, diagnostic support, impact of deployment of vector control and even estimates of the time required to eliminate the

disease. Data were collected in different endemic areas, with different spatial and environmental variables, and with different epidemiological characteristics.

The **Spatial Ecology & Epidemiology Group (SEEG), University of Oxford** is working to **model the spatial distribution of undetected HAT cases** continent-wide based on the data provided by the HAT Atlas. Using a Bayesian geostatistical modelling and considering two components (different environmental factors and spatial correlation), the model attempts to estimate:

- the true number of cases (not only reported cases) where there is surveillance and where there is not;
- the effectiveness of passive case-finding; and
- the uncertainty in these estimates.

Within the **NTD Modelling Consortium**, two independent groups (the University of Warwick and Yale University) are working to **model transmission of gambiense HAT and estimate the probability of elimination**. The model tries to forecast the impact of different strategies to reach elimination based on reported cases (active and passive). It has been applied in two different areas (the Boffa focus of Guinea and in Yasa Bonga/Mosango in the Democratic Republic of the Congo). This modelling can help to estimate the level of underreporting. It works also in estimating the risk of recrudescence in infection-free area and the role that animal reservoirs or undetected human infections could play in the recrudescence of the disease.

The **Institute for Disease Modelling** is working in the Democratic Republic of the Congo to **map the spatial risk of gambiense HAT and guide the deployment of control interventions** through a dynamic disease model, starting first with an improvement of data collection and management. The model uses spatio-temporal covariates with historical case records to predict the prevalence of gambiense HAT and applies these data for operational planning. The possible interventions are explored according to defined parameters. It is exploring its applicability to:

- predict elimination dates;
- impact of changes to passive and active surveillance;
- impact of vector control;
- impact of switching from current treatment protocols to new therapies;
- impact of different screening methods; and
- potential role of trypanotolerance.

Remarks

Decision-makers and modellers should have a certain level of knowledge of each other's field in order to build a healthy, constructive relationship. Modellers working on epidemiological healthcare problems cannot ignore the specific facts and context that govern the data and the less mathematical issues of healthcare. Likewise, decision-makers engaging modellers should not view models as mystical "crystal balls" from which irrefutable answers emerge, while remaining aware of the limitations of both the method and the data quality.

In the current gambiense HAT epidemiological situation, many variables may introduce important bias in a model. Blind spots, for instance, are a problem for mapping: they may harbour cases, but not report, as they may as well have no cases at all. Underreporting is, therefore, an important bias. Thus, model validation is very difficult. There is a need to

exercise great caution when interpreting models where the levels of uncertainty are high. Modelling in gambiense HAT needs to reduce uncertainty in order to obtain useful results. One of the main difficulties to modellers is to find robust data which may be studied with confidence. If data are uncertain, they should be treated cautiously.

7.4 Vector control

The **Vector Group** – a collaboration of researchers from academia, governmental and private institutions (CIRDES, DVS, ICIPE, IRD, ITM, CEVA, LSTM and Vestergard-Frandsen) – presented the results of field trials using “tiny targets” (small insecticide-impregnated fabric screens, attractive to tsetse flies) developed by the group, to control riverine tsetse in countries where gambiense HAT is endemic. The results of a study in Uganda (riverine forest) showed a 92% reduction of tsetse populations after 3 years of deploying and maintaining 2872 tiny targets over an area of 500 km². The economic analysis showed that the implementation of tiny targets was cost-effective. In Guinea in the Boffa focus (mangrove environment), after a combined vector control and active case detection campaign, the incidence of gambiense HAT decreased to 0.07 cases/year, compared with 1.4 cases/year in an adjacent area where no targets were deployed.

Some additional trials in different types of environment are ongoing. In Chad in the Mandoul focus (marsh/swamp environment), preliminary results showed a 99% reduction of flies after 6 months of deployment. In Côte d’Ivoire in the Bonon focus (degraded forest) the area to be covered is around 100 km², and in Yasa Bonga, Democratic Republic of the Congo, there are plans to cover an area of 500 km², with the possibility of future expansion to 3000 km² in 2018. A guidance document for national programmes on the use of tiny targets has been produced. This Vector Group project is deploying approximately 60 000 targets annually covering 6000 km² in 11 foci of five countries and achieving a more than 80% reduction in tsetse numbers in these areas.

Tiny targets are twice as effective, 10 times cheaper, longer-lasting (6 months) and easier to deploy than traditional traps. The annual cost of their deployment and maintenance is estimated to be US\$ 46/km², rising to US\$ 85/km² after allowing for costs of community sensitization, monitoring and office overheads.

Issues raised during the discussion

- The impact of vector control on HAT transmission, when the intervention happens at the same time as active case detection activities, must be carefully analysed.
- The efficacy of tiny targets relies on a good selection of deployment sites, which requires a pre-intervention survey using tsetse traps.
- Sustainability of vector control: tsetse flies return to target areas only a few months after the end of the control campaign.
- Financial support from the government and/or partners is required because deploying and maintaining tiny targets in rural areas is difficult, as they need regular replacement.

The collaboration among WHO, FAO, the African Union and the International Atomic Energy Agency within the frame of the Program Against African Trypanosomiasis (PAAT) has yielded two atlases:

- the Atlas of human African trypanosomiasis (HAT), which is led by WHO and jointly implemented with FAO; and

- the Atlas of Tsetse and Animal Trypanosomosis (AAT), which generates maps showing the distribution of tsetse flies and animal trypanosomosis, including the geographical distribution of human trypanosomes found in cattle.

Many countries use these tools in several ways.

FAO and IAEA are also working in the vector control field to study different arthropods and the effect of viruses (SGHV, salivary glands hypertrophy virus), symbionts (*Sodalis*) and *Wolbachia* as tools for vector control. A study in Senegal in the Deme River, with sterile male tsetse, produced very good results.

PATTEC bases its general strategy on advocacy to African governments for eradication of the vector through simultaneous and coordinated joint action. PATTEC promotes the integration and transfer of appropriate technologies and approaches based on good policy, strategic development and high-quality databases oriented to results, using a dynamic and participatory approach to the programmes.

Remarks

The need for vector control activities as a tool for the elimination of gambiense HAT was emphasized during the discussion on epidemiological tools. A meeting on vector control will be organized by WHO within the HAT elimination network in 2017.

8. Assessment of elimination

8.1 Validation and verification

The intermediate goal of the HAT WHO control and surveillance programme is “to eliminate HAT as a public health problem” by 2020; its further goal is “to interrupt transmission of gambiense HAT (sustainable elimination)” by 2030. The programme has been mainly supported by a public–private partnership with Sanofi and Bayer since 2001.

As the elimination goal is approaching as expected, the principles, processes and tools for validating the elimination status in countries are required (Figure 21 and Figure 22).

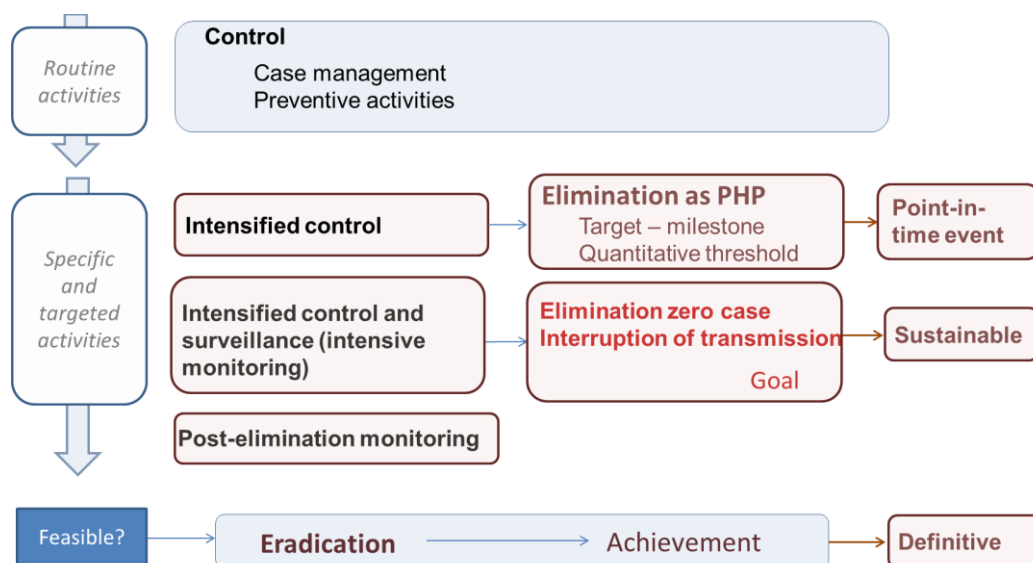

PHP, public health problem

Figure 21. Guiding principles for the evolution of control of neglected tropical diseases

CONCEPT	DEFINITION	PROCESS OF DOCUMENTATION	GEOGRAPHICAL AREA	FOLLOW UP
Elimination as a public health problem	Achievement of measurable global targets defined	VALIDATION	Country	Continued actions are required to maintain the targets
Elimination of transmission (interruption of transmission)	Reduction to zero of the incidence of infection caused by a specific pathogen, in a defined geographical area, with minimal risk of reintroduction.	VERIFICATION	Country, area, region	Continued actions (effective surveillance and response systems) are needed to prevent re-establishment of transmission
Eradication	Permanent reduction to zero of a specific pathogen, as a result of deliberate efforts, with no more risk of reintroduction	CERTIFICATION	Global	No further actions are needed
Extinction	eradication of the specific pathogen that no longer exists in nature or the laboratory		Global	No further actions are needed

Source: WHO Strategic and Technical Advisory Group for Neglected Tropical Diseases, 2015

Figure 22. Principles and processes for confirming elimination of neglected tropical diseases

The formal recognition of the elimination of gambiense HAT as a public health problem requires a validation process, whereas the elimination as zero cases needs a verification process.

The full set of criteria and procedures to assess HAT elimination has to be set up by the Scientific Consultative Group, which includes the Technical Advisory Group for HAT elimination (HAT-e-TAG). It has been advanced that countries will be requested to prepare a validation/verification file following WHO guidelines that will be developed. Data requested could include information on the performance and monitoring of the surveillance system in those areas where the country claims to have eliminated HAT.

A framework for validating the elimination of neglected tropical diseases has been established by the WHO Strategic and Technical Advisory Group for Neglected Tropical Diseases. The process of validation proposed for elimination of HAT starts at the country level. First, the validation file is assembled by the national authorities according to a template, then submitted to WHO. The dossier is examined by a WHO HAT technical advisory group for completion of requirements and compliance with specific standard operating procedures. If the recommendation of the validation technical advisory group is positive, then the elimination as a public health problem in the country is recognized and therefore validated by WHO, and the new status is posted in the Global Health Observatory with the date at which the status is to be updated; reporting must be continued during post-elimination surveillance. The technical advisory group may decide that the dossier does not substantiate the claim, in which case the response communicated to the country indicates the insufficiencies and provides recommendations for the way forward (Figure 23).

The verification process (for full elimination) has yet to be defined. For measuring the progress towards gambiense HAT elimination, primary and secondary indicators will be adapted to the national level.

A technical advisory group to assess HAT elimination has been formally established and approved by WHO. This group will assist in establishing:

- templates, to prepare the national dossiers of validation/verification of HAT elimination for submission to and review by WHO;

- procedures and criteria, to review the national dossiers and for assessing whether the requirements for validation and/or verification have been met in the Member State; and
- procedures to follow up the post-elimination surveillance and periodically to revise the status of HAT elimination in the Member State.

This group will periodically review the process of validation/verification of HAT elimination according to the new scientific advances and tools available.

The Technical Advisory Group for HAT Elimination will:

- comprise 10–15 members selected from the Expert Advisory Panel and appointed by WHO;
- reflect a balance of personal experience, professional background, gender and geographical origin;
- declare and be free of any conflicts of interest;
- be impartial and independent, as required by WHO, and not accept instructions from any government or from any authority external to the Organization;
- may include, at WHO’s invitation,
 - additional experts to participate in meetings and provide advice on specific issues; and
 - representatives from intergovernmental organizations (organizations of the United Nations system).

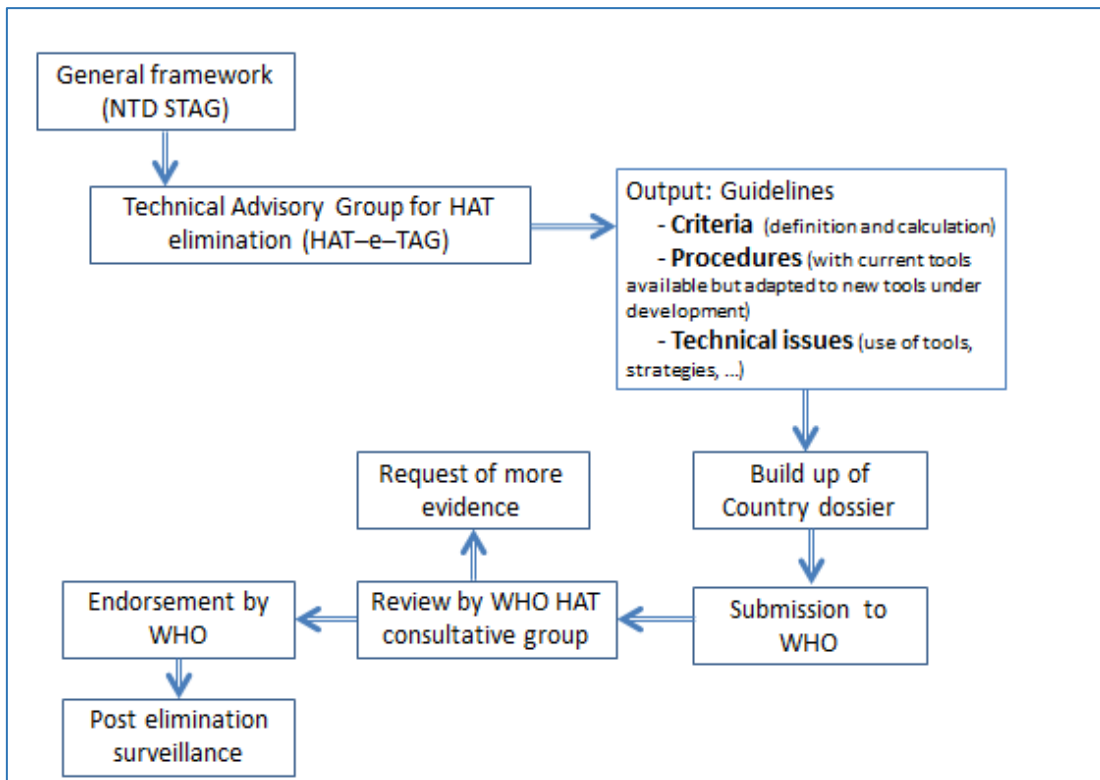

HAT, human African trypanosomiasis; NTD STAG, WHO Strategic and Technical Advisory Group for Neglected Tropical Diseases

Figure 23. Algorithm of process for validation of HAT elimination

8.2 Passive surveillance: the experience of West Africa

The advances in the control of gambiense HAT are remarkable. Despite the weaknesses in epidemiological surveillance, the gradual decrease in the numbers of cases reported from 2000 onwards reflects a real decline in the incidence of the disease. However, in order to ensure its sustainability, there is a pressing need to set up a surveillance system adapted to the epidemiological situation and integrated into the existing health system.

Integrated sentinel reactive surveillance provides an innovative response by integrating surveillance of gambiense HAT in each country's national health services. Implementation, monitoring and evaluation are the responsibility of the Ministry of Health; WHO provides support. The model establishes a warning system from sentinel sites which are based in referral hospitals from areas where endemic HAT has been reported. The warning system identifies new cases and responds with targeted active screening in the original area of the detected cases. It represents less effort at a more affordable cost.

Gambiense HAT is a chronic disease, and in areas where transmission is very low or nil, its diagnosis is complex.

Clinical and/or laboratory diagnostic evaluations in peripheral health centres may be unable to detect people infected with HAT, who may then present at referral centres that should be able to detect these cases. Thus, the health facilities located in endemic areas must be evaluated in order to select the most suitable sentinel sites. It will be important to consider:

- level of use and geographical coverage
- quality of personnel
- functionality and laboratory capacity
- organization of care and supervision.

This model has been used in several countries of the subregion with similar epidemiological situations (Burkina Faso, Ghana, Mali, northern Guinea and Niger). The experience of the integrated surveillance of gambiense HAT in this area is a model to follow in other countries.

In Burkina Faso, a locally-acquired gambiense HAT case has been diagnosed 10 years after the absence of any reported indigenous cases; a reactive investigation at community level is under preparation.

Despite its weaknesses, integrated reactive sentinel surveillance continues to be functional in Benin and Togo after 5 years. About 20 000 people have been examined for HAT and no cases have been detected. The new, simpler individual screening tests facilitate this type of surveillance.

Integrated passive screening of gambiense HAT must be maintained until elimination and beyond, and coordinated efforts among partners is required for synergistic action. Internal and external financial resources to continue the activities of supervision and coordination meetings must be ensured and ways found to maintain the motivation of technical staff.

8.3 Challenges of integrated control and surveillance

The integration of gambiense HAT diagnosis in the national health services of endemic countries may present several problems and challenges.

- **Quality of diagnosis** In health centres where transmission of the disease is high, staff deal with gambiense HAT frequently, and clinical suspicion and laboratory work are usually done correctly; but in areas of low transmission, health workers lack the

reflex to think about this disease, which has become uncommon, laboratory staff are unfamiliar with HAT tests, and patients often return to the health centre several times until a HAT diagnosis is made.

- **Use of health services** In most of the countries where the disease is endemic, use of the health service is low (e.g. in the Democratic Republic of the Congo only 0.15 visits/person per year), health centres are usually poorly equipped and may struggle with diagnosis, even if gambiense HAT is clinically recognized. Future oral treatments able to treat both stages could avoid mandatory lumbar puncture for treatment and may increase the willingness of patients to present at diagnostic points. A future combined malaria/HAT RDT may be a tool for the identification of HAT in patients using the local health service for the malaria diagnosis.
- **Syndromic algorithms** Although syndromic algorithms for diagnosis are sensitive, their specificity (< 10%) will decrease with lower prevalence. Therefore health care workers will be less attentive to HAT diagnosis when most patients test negative. Keeping motivation high among health personnel will be a challenge.
- **Rapid screening tests** Rapid screening tests have good specificity, but as the incidence of HAT decreases an increasing proportion of positive results will be false-positives, demanding further laboratory work on suspected patients and leading very frequently to a negative result.

The progressive change from mixed active and passive case detection to purely passive surveillance could have repercussions for several of gambiense HAT activities and goals.

- **Monitoring of trends** Passive screening alone will identify a lower proportion of cases at more advanced stages of the disease, and caution must therefore be exercised in interpreting surveillance data. Modelling may help to estimate the extent of undetected infections, depending on the focus and the quality of data.
- **Interrupting transmission and achieving elimination** There are risks of infected people not being diagnosed and becoming a residual reservoir of the disease. Also, when HAT is diagnosed by passive screening, a higher proportion of patients has stage 2 disease, having served as reservoirs of the infection for a longer time. Finally, asymptomatic individuals who can serve as effective infection reservoirs will not be detected by passive surveillance.

Therefore the elimination programme will need to:

- optimize the integration of passive HAT surveillance into the health system;
- provide training and refresher courses in clinical and parasitological diagnosis and/or devise a clear referral system for diagnostic assistance and clinical management;
- supply health centres with appropriate materials and equipment;
- devise quality assurance procedures; and
- implement targeted vector control when needed.

9. Open floor for stakeholders

The meeting was attended by high-level representatives of most of the stakeholders involved in the fight against gambiense HAT. At an open session, stakeholders delivered the following key messages.

- Focal points from SSNCPs reiterated the need for better communication among countries and strong coordination by WHO in leading the elimination of HAT. The representative of the Democratic Republic of the Congo manifested his concern about the possibility of the end of financial support from Belgium, as well as the problem of the weak coverage in a number of areas and how to extend it.
- The Drugs for Neglected Diseases *initiative* (DNDi) accords with and is framed on the elimination of HAT. New tools for diagnosis and treatment, support for the development of drugs for paediatric use, new approaches in the field of anthropology and better characterization of the role of asymptomatic carriers are needed. Positive trends should not lead to the end of support.
- The Foundation for Innovative New Diagnostics (FIND) reaffirmed its commitment to the collaboration with WHO that began in 2006 and supports WHO in the elimination process.
- The Institute of Tropical Medicine (ITM) highlighted the need for more knowledge in parasitological diagnosis, including in domestic animals.
- The Institute for Research and Development (IRD) stressed the importance of integrated tools and strategies adapted to low prevalence contexts. Sustainability is an important issue to be addressed, as are efforts to support training.
- The Liverpool School of Tropical Medicine (LSTMH) will continue its vector control activities in support of the WHO HAT elimination target.
- The Institut National de Recherche Biomédicale (INRB) will continue to produce mAECT, reducing its price and doubling the production. It agrees that the global strategy for gambiense HAT elimination should combine diagnosis, treatment and vector control.
- The University of Glasgow reaffirmed the importance of integrated responses, including on new diagnostic tools, new drugs and vector control. It defends strategies to obtain a sustained engagement of the population and the stimulation of donors, by enlisting an international personality to advocate with the global HAT community.
- The modelling groups reiterated the importance of models in gambiense HAT elimination, and the need for combined data on diagnosis, treatment and vector control.
- Médecins Sans Frontières (MSF) renewed its commitment to fighting HAT but warned of the difficulties of a long fight to attain elimination. It is optimistic about the new drugs, proving that without research there is no success, and that lack of interest will provoke a new disaster.
- The African Union/PATTEC (Pan-African Tsetse and Trypanosomiasis Eradication Campaign) stressed the crucial need for support to national programmes: healthy people means good agriculture and livestock. It supports the consensus on the integration of vector control in the global strategy of gambiense HAT elimination.
- The Food and Agriculture Organization of the United Nations (FAO) and the International Atomic Energy Agency (IAEA) confirmed their continued commitment to and alignment with WHO on the elimination of HAT; both organizations are involved in HAT control in the framework of the Programme Against African Trypanosomiasis (PAAT). It was suggested to include elimination in the context of One Health, which would raise new possibilities of funding. On modelling, FAO reaffirmed its importance to gambiense HAT control, but advised caution when uncertainty levels are high.

- Bayer Health Care announced that in addition to donating medicines, it will continue to support other activities.
- The Bill & Melinda Gates Foundation (BMGF) said that the HAT situation in Benin and Togo shows that HAT elimination is possible. It reaffirmed its intention to maintain support towards that objective through the financial help to developing control tools (diagnostics, treatment and vector control), channelled mainly through research and development partners. Attention was drawn to some still unknown factors that may interfere in the elimination goal, such as intermediate hosts and asymptomatic carriers. Economics are also an issue, as escalation of costs will be high, and there will be more difficulties in mobilizing donors. Links to other involved parties must be started, and gambiense HAT must be included in One Health objectives.
- Sanofi stressed that what has been done includes not only the provision of treatment but also the support to many other areas. New hurdles will now appear, such as the loss of interest, loss of expertise, and the risk of the advances becoming slower and slower; teamwork and collaborative efforts are needed now more than ever. Sanofi will continue to accompany the process until HAT is eliminated.

10. Conclusions

1. Significant progress has been made since the first stakeholders meeting (March, 2014). The indicators established show that we are on track to meet the 2020 goal of elimination of gambiense HAT as a public health problem. Nevertheless, appropriate funding, ownership by endemic countries and political civil stability are required in all endemic areas to ensure appropriate field actions and sustainability of the current trend.
2. The network for gambiense-HAT elimination, led by WHO, has shown its pertinence, being highly active in the past 2 years. It has ensured the coordination and synergy of different stakeholders' activities, which are becoming increasingly critical as we advance further towards elimination.
3. Important efforts have been made to maintain the intensity of activities of control programmes in disease endemic countries. The number of cases reported continues to decrease and the number of areas of unknown epidemiological status has been reduced. However, more efforts from countries are needed to:
 - ensure continued staff training and motivation;
 - integrate control and surveillance into strengthened national health systems;
 - enhance cross-border collaboration; and
 - increase the level of commitment to support HAT control and surveillance to contribute fully to the goal of elimination.
4. Case-finding is central to elimination. Access to the best screening and diagnostic tools must therefore be assured. Innovative active and passive case-finding strategies should be developed while ensuring sufficient coverage of populations at risk.
5. As new diagnostic tools are developed, independent, multicentre evaluation is important and all initiatives in this regard are encouraged.
6. Progress in the development of new oral drugs capable of curing both stages of the disease is encouraging and is expected to simplify case-management and facilitate access to treatment. If development is successful, the first new 10-day oral treatment is

expected in late 2018; it will be important to formulate a registration plan, and integration into control strategies and policies. Additionally, a single-dose oral treatment is also in development.

7. Existing and innovative tools for vector control are effective in decreasing vector abundance and have great promise of contribution in reducing disease transmission when strategically deployed and coordinated with medical intervention.
8. Effective data collection, management and mapping are crucial for monitoring disease progress and subsequent decision-making, and should be sustained and strengthened.
9. Epidemiological modelling has a role to play in formulating strategies and estimating their impact. However, uncertainty in modelling must be taken into account and caution exercised to avoid over-interpreting model outputs.
10. Research needs include understanding the epidemiological roles of asymptomatic human carriers and animal reservoirs.
11. To achieve elimination, strong links to other disciplines are required. These include a social sciences perspective to enhance community engagement, and veterinary services under the One Health concept.
12. Gambiense-HAT endemic countries have requested WHO to accelerate the construction of the procedures for validation of elimination that are under development.

Annex 1. Agenda

Second WHO stakeholders meeting on gambiense human African trypanosomiasis elimination 21–23 March 2016, WHO, Geneva (Room C)

Time	Topic	Detail	Presenter
Monday 21 March 2016			
08:30–09:00	Registration and administrative procedures		
09:00–09:45	Welcome	Addresses by WHO	ADG HTM/NTD Director DPC/AFRO Director NTD/HQ Coordinator IDM/HQ
09:45–10:45	Introduction	Presentation of the meeting Progress on g-HAT elimination	Chairperson J.R. Franco, WHO
10:45–11:15	Coffee break		
11:15–11:45	Implementing NGOs	MSF (MSF-CH, MSF-S, MSF-H)	NGO focal point
11:45–12:30	Country epidemiological report (I)	Epidemiological 2015 update: - West Africa (Benin, Togo, Côte d'Ivoire, Guinea, Ghana, Burkina Faso, Mali, Nigeria)	National Coordinators Sleeping Sickness Programmes
12:30 – 14 :00	Lunch		
14:00–15:30	Country epidemiological report (II)	Epidemiological 2015 update: - East Africa (South Sudan, Uganda) - Central Africa (Angola, Cameroon, Central African Republic, Chad, Congo, Democratic Republic of the Congo, Equatorial Guinea, Gabon)	National Coordinators Sleeping Sickness Programmes
15 :30–16:00	Coffee break		
16:00–17:30	Country priorities report	- Priorities and support needed - Discussion	National Coordinators Sleeping Sickness Programmes

Time	Topic	Detail	Presenter
Tuesday 22 March 2016			
09:00–09:30	WHO Network for gambiense-HAT elimination	Report 2014-2015	G. Priotto, WHO
09:30–11:00	Screening and diagnosis	Report of the Working Group on Integration of new diagnostic tools Update on development of new diagnostic tools - FIND - ITM DITECT-HAT project Discussion	M. Barrett S. Biéler P. Buscher V. Lejon All
11:00–11:30	Coffee break		
11:30–12:30	Treatment	Report of Working Group on Integration of new treatment tools Update on development of new treatment tools Discussion	J. Seixas N. Strub All
12:30–13:30	Lunch		
13:30–15:00	Epidemiological tools (I): New approaches for case detection	Current situation: gaps and needs Extending the integrated reactive surveillance system: sentinel sites Rationalizing active case-finding efforts Intensifying surveillance for passive case-finding	A. Moore G. Priotto, WHO E. Hasker J. Ndung'u

15:00–16:00	Epidemiological tools (II): <i>Improving knowledge</i>	Calculation of active and passive case-finding coverage	G. Priotto, WHO
		Update on the roles of animal reservoir and healthy human carriers to maintain gambiense HAT transmission Discussion	B. Bucheton All
16:00–16:30	Coffee break		
16:30– 18:00	Epidemiological tools (III): <i>Attempts to estimate the unknown</i>	Underdetection of gambiense-HAT: a Bayesian geospatial model	G. Cecchi, on behalf of N. Golding, SEEG
		Modelling gambiense HAT transmission: estimating probability of elimination Modelling HAT risk to support diagnostics and vector control deployment Discussion	M. Keeling, NTD modelling consortium (Warwick/Yale) C. Bever, IDM All

Time	Topic	Detail	Presenter
Wednesday 23 March 2016			
09:00–10:00	Vector control	Activities of PAAT (FAO / IAEA) on tsetse control Activities of PATTEC on advocacy and coordination of tsetse control Projects of LSTMH/IRD: Guinea, Chad, Uganda, Democratic Republic of the Congo Discussion	G. Cecchi / M. Vreysen G. Wanda, PATTEC S. Torr / M. Lehane All
10:30–11:00	Coffee break		
11:00–12:30	Assessing-HAT elimination: verification and validation	Validation and verification of elimination: procedures and steps Experience in West Africa Discussion	J.R. Franco, WHO A. Diarra, WHO All
12:30–13:00	Open floor for stakeholders	Statements and discussion	All
13:00–14:30	Lunch		
14:30–16:00	Conclusions and outcomes		Chairperson
16:00	Farewell coffee		

Annex 2. List of Participants

Sleeping Sickness Control Programmes

Dr Ifeoma Anagbogu
National Programme Coordinator
Nigeria Guinea worm Eradication Programme (NIGEP/HAT)
Department of Public Health
Federal Ministry of Health
Federal Secretariat, Phase 3, 9th floor
Maitama District, P. O. Box 8426
Wuse Post Office, Abuja
Nigeria
Tel: +234 80 34 08 56 07 / 80 44 10 46 63
E-mail: ifechuba@yahoo.co.uk

Dr Julienne Atsame
Directeur du Programme de lutte contre les maladies parasitaires
Point focal du Programme national de lutte contre la trypanosomiase humaine africaine (PNLTHA)
B.P. 2434 Libreville
Gabon
Tel: +241-06047314
E-mail: ntseme2007@yahoo.fr

Mr Thomas Azurago
Assistant Chief Technical Officer
Ghana Health Service
Disease Control & Prevention Department
P. O Box KB 493, Korle – Bu, Accra
Ghana
Tel: +233 32689843 / Cell: +233 243329133
E-mail: thomzurago@yahoo.com

Dr Kossi Badziklou
Coordonnateur du Programme THA
Directeur Adjoint Institut National d'Hygiène
Chef Labo de Référence MPE
Chef Labo Microbiologie Alimentaire
Coordinateur PNLTHA
BP 1396, Lomé
Togo
Tel: +228 90 94 52 00 / 99 49 89 69
E-mail: pnlthatogo@yahoo.fr

Dr Wilfrid Etienne Batcho
Coordonnateur du Programme national de lutte contre les Maladies transmissibles
Point focal du Programme national de lutte contre la trypanosomiase humaine africaine (PNLTHA)
Ministère de la Santé, 03 BP 1061, Cotonou
République du Bénin
Tel: + 229 95 79 51 19 et 229 97 02 77 28
E-mail: wbatcho@yahoo.fr

Dr Mohamed Berthé
Coordonnateur du Programme National de lutte contre la THA / Santé bucco-dentaire et Noma
Direction Nationale de la Santé
Ministère de la Santé, Bamako
République du Mali
Tel: +223 65 24 96 20 / 94 76 76 04
E-mail: mohberthe1@yahoo.fr

Dr Mamadou Camara
Coordonnateur National du Programme de Lutte contre la Trypanosomiase Humaine Africaine
Division prévention
Ministère de la Santé publique
Boîte Postale 817 SC OMS/Guinée, Conakry
République de Guinée
Tel: +224 664 83 71 99 / +224 60 598946
E-mail: mamadycamaraf@ yahoo.fr

Dr Ayak Chol Deng Alak
Directorate of Preventive Health Services
Ministry Of Health-RSS, Juba
Republic of South Sudan
Tel: ++211(0)927672217
E-mail: ayakcholalak@gmail.com

Dr Pierre-Marie Douzima
Médecin de Santé Publique
Coordonnateur du Programme de Lutte contre la Trypanosomiase Humaine Africaine
Ministère de la Santé Publique et de Lutte contre le Sida, Bangui
République Centrafricaine
Tél: +236 75 50 06 79/77 31 94 21
E-mail: douzima2006@yahoo.fr

Mr Vincent Ebo'o Eyenga
Secrétaire Permanent du Programme de Lutte contre la Trypanosomiase Humaine Africaine
Direction de la Lutte contre la Maladie, Yaoundé
Cameroun
Tel: +237 22 23 93 48
Mob: +237 77 35 41 14 / + 237 677 35 41 15
Fax: +237 22 22 44 19
E-mail: eboeyengavincet@yahoo.fr

Professor Théophile Josenando
Director Instituto de Combate e Controlo das Tripanossomíases, ICCT/MINSA
Rua Comandante Kwenha 168-170
Ingombota, C.P. 2657, Luanda
Angola
Tel: +244 222 399610/11
Mob: +244 923 404577
Fax: +244 222 371243
E-mail: josenandot@yahoo.com

Dr Lingué Kouakou
Directeur/Coordonnateur, Programme National d'Elimination de la Trypanosomiase Humaine Africaine (PNETHA)
17 BP 934, Abidjan 17
Côte d'Ivoire
Tel: +225 20-22-80-29
Mob: +225 07-64-38-66 or +225 40-31-08-41
Fax: +225 20-22-80-35
E-mail: linguek@yahoo.fr

Dr Crispin Lumbala
Directeur, Programme National de Lutte contre la Trypanosomiase Humaine Africaine
Ministère de la Santé Publique
Avenue croisement libération et Bd Triomphal No. 1, Commune de Kasavubu
Kinshasa
République Démocratique du Congo
Tel: +243(0)99 00 27 220
E-mail: doccrislumbala@yahoo.fr / crispinlumbala@gmail.com

Dr Jacques Makabuza
CD Survepi, Programme National de Lutte contre la Trypanosomiase Humaine Africaine
Ministère de la Santé Publique
Avenue croisement libération et Bd Triomphal No. 1, Commune de Kasavubu
Kinshasa
République Démocratique du Congo
Tel: +243 9999 02 425
E-mail: jacqueline2fr@yahoo.fr

Mr Peka Mallaye
Responsable du Programme National de Lutte contre la Trypanosomiase Humaine Africaine
BP 440, N'Djaména
Tchad
Tel: +235 66281579
E-mail: peka_mallaye@yahoo.fr

Dr Pedro Ndongo Asumu
Director del Programa nacional de control de la tripanosomiasis humana africana
Ministerio de Salud Publica
00270 Bata – Litoral
Equatorial Guinea
Tel: +240 222 257767
Fax: +240 333 082095
E-mail: ndongoasumu@yahoo.es / tereleane@hotmail.com / pedrondongoasumu@yahoo.es

Dr Bienvenu Rolland Ossibi Ibara
Chef du Programme National de Lutte contre la Trypanosomiase Humaine Africaine
Ministère de la Santé et de la Population
B.P. 1066, Brazzaville
République du Congo
Tel: +242
E-mail: bienvenu_07@yahoo.fr

Mr Ousmane Elie Ouedraogo
Chef de l'unité de lutte contre la trypanosomiase humaine africaine
Ministère de la Santé
B.P. 7009, Ouagadougou
Burkina Faso
Tel: +226 70 68 93 64 / 76 56 02 81
E-mail: ouseliouedraogo@yahoo.fr

Dr Charles Wamboga*
Coordinator, National Sleeping Sickness Control Programme
Ministry of Health
Vector Control Division
P.O.Box 1661, Kampala
Plot 15 Bombo Road, Kampala
Uganda
Tel: +256-77-4-567780
E-mail: cwamboga@gmail.com

Mr Erphas Olema
Regional HAT Coordinator (West Nile Region)
National Sleeping Sickness Control Programme
Vector Control Division
Ministry of Health
P. O. Box 1661, Kampala
Uganda
Tel: +256 77 255 08 04
E-mail: erphasolema@yahoo.co.uk

WHO collaborating centres

Professor Philippe Büscher
Director, WHO Collaborating Centre for Research and Training on human African trypanosomiasis diagnostics
Parasite Diagnostics Unit, Department of Parasitology
Institute of Tropical Medicine Antwerp
Nationalestraat 155, 2000 Antwerpen
Belgium
Tel: +32 3 247 63 71
Fax: +32 3 247 63 73
E-mail: pbuscher@itg.be

Dr Vincent Jamonneau*
Director, WHO Collaborating Centre for research on interactions on epidemiology of human African trypanosomiasis
Institut de Recherche pour le Développement (IRD), UMR 177 / CIRDES
BP 454 Bobo-Dioulasso
Burkina Faso
Tel.: +226 20 97 62 15
Mob.: +226 76 06 79 51
E-mail: vincent.jamonneau@ird.fr

Research and development partners

Drugs for Neglected Diseases *initiative* (DNDi)

15 Chemin Louis-Dunant
1202 Geneva
Switzerland

Dr Bernard Pecoul
Executive Director
Tel: +41 22 906 92 33
Fax: +41 22 906 92 31
E-mail: bpecoul@dndi.org

Dr Nathalie Strub-Wourgaft
Medical Director
Tel: +41 22 906 92 46
Fax: +41 22 906 92 31
E-mail: nstrub@dndi.org

Dr Antoine Tarral
Head of HAT programme
Tel: +41 22 906 92 60
Fax: +41 22 906 92 31
E-mail: atarral@dndi.org

Dr Olaf Valverde
Medical coordinator of HAT programme
Tel: +41 22 906 92 39
Fax: +41 22 906 92 31
E-mail: ovalverde@dndi.org

Foundation for Innovative New Diagnostics (FIND)

Campus Biotech, Chemin des Mines
1202 Geneva
Switzerland

Dr Catharina Boehme*
Chief Executive Officer
Tel: +41 22 710 93 16
Fax: +41 22 710 05 99
E-mail: catharina.boehme@finddiagnostics.org

Dr Joseph Ndung'u
Head HAT & Other Neglected Diseases Programme
Tel: +41 22 710 93 11
Fax: +41 22 710 05 99
E-mail: joseph.ndungu@finddiagnostics.org

Mr Sylvain Biéler
Project Manager
Tel: +41 22 710 27 81
Fax: +41 22 710 05 99
E-mail: sylvain.bieler@finddiagnostics.org

Dr Albert Picado
Senior Scientific Officer
Neglected Tropical Diseases Programme
Tel: +41 22 710 27 89
E-mail: Albert.picado@finddx.org

ICIPE - African Insect Science for Food and Health

P.O. Box 30772-00100, Nairobi
Kenya

Dr Rajinder Saini
Principal Scientist, Tsetse Programme Leader and Head of Animal Health Division
Tel: +254 (20) 86 32 010
E-mail: rsaini@icipe.org

Institut de Recherche pour le Développement (IRD)

TA A 17/G Campus International de Baillarguet
34398 Montpellier cedex 5
France

Dr Philippe Solano
Directeur UMR IRD/CIRAD 177 INTERTRYP
Tel: +33 (0) 467 593 835
Fax: +33 (0) 467 593 894
Secr: +33 (0) 467 593 919
E-mail: philippe.solano@ird.fr

Dr Bruno Bucheton
Research Officer at IRD
UMR IRD/CIRAD 177 INTERTRYP
Affecté en Guinée
Ministère de la Santé et de l'Hygiène Publique
Programme National de Lutte contre la THA (PNLTHA)
Bureau face au jardin du 2 octobre, Conakry
République de Guinée
Tel: +224 669 93 97 55
E-mail: bruno.bucheton@ird.fr

Dr Veerle Lejon
Directeur de Recherche
Tel: +33 467593950
E-mail: veleon@ird.fr

Institut National de Recherche Biomédical (INRB)

Avenue de la Démocratie, B.P. 1197 Kinshasa Gombe
République Démocratique du Congo

Professor Dieudonné Mumba-Ngoyi
Tel: +243 (81) 81 18 511
E-mail: mumbadieudonne@yahoo.fr

Institute of Tropical Medicine (ITM)

Nationalestraat 155, B-2000 Antwerpen
Belgium

Professor Bruno Gryseels
Director
Tel: +32(0)32476200
E-mail: BGryseels@itg.be

Professor Marleen Boelaert*
Head of Unit of Epidemiology and Control of Tropical Diseases
Tel: +32 (0) 32476283
E-mail: mboelaert@itg.be

Dr Geert Laleman
E-mail: glaleman@itg.be

Dr Epcó Hasker
Scientific collaborator, Unit of Epidemiology and Control of Tropical Diseases
Tel: +32 (0) 3247072632
E-mail: ehasker@itg.be

Instituto de Higiene e Medicina Tropical

Universidade Nova de Lisboa
Rua da Junqueira 96, 1349-008 Lisboa
Portugal

Dr Jorge Seixas
Unidade de Clínica das Doenças Tropicais
Tel: + 351 21 365 26 61
Fax: + 351 21 363 21 05
Mobile + 351 91 657 97 24
E-mail: JSeixas@ihmt.unl.pt

Makerere University

Department of Parasitology & Microbiology
PO Box 7062, Kampala
Uganda

Professor Enock Matovu
Senior Lecturer, Faculty of Veterinary Medicine
Tel: +256 772 550 226
E-mail: matovue04@yahoo.com

Swiss Tropical and Public Health Institute (SwissTPH)

Socinstrasse 57, 4002 Basel
Switzerland

Professor Christian Burri
Head, Department of Medicines Research
Tel: +41 61 225 26 61
Fax: +41 61 225 26 78
E-mail: Christian.Burri@unibas.ch

Dr Fabrizio Tediosi
Health Systems Research & Dynamical Modelling Unit
Department of Epidemiology and Public Health
Tel: +41 61 284 87 19
E-mail: Fabrizio.Tediosi@unibas.ch

University of Glasgow

Professor Michael P. Barrett
Professor of Biochemical Parasitology
Wellcome Trust Centre for Molecular Parasitology
Institute of Infection, Immunity and Inflammation
College of Medical Veterinary and Life Sciences
Glasgow Biomedical Research Centre
University of Glasgow
120 University Place, Glasgow G12 8TA,
United Kingdom
Tel: +44(0) 141 330 6904
Fax: +44 (0) 141 330 4600
E-mail: Michael.Barrett@glasgow.ac.uk

University of Liverpool / Liverpool School of Tropical Medicine

Professor Eric Fèvre*
Chair of Veterinary Infectious Diseases
Institute of Infection and Global Health
University of Liverpool, Leahurst Campus
Neston, CH64 7TE
United Kingdom
Mob: +254 722 545345
Tel: +44 151 3241241
E-mail: Eric.Fevre@liverpool.ac.uk

Professor Michael J. Lehane
Professor of Molecular Entomology and Parasitology
Vector Group
Liverpool School of Tropical Medicine
Pembroke Place, Liverpool L3 5QA,
United Kingdom
Tel: +44 (0)1248 490681
E-mail: Mike.Lehane@lstm.ac.uk

Professor Steve Torr
Liverpool School of Tropical Medicine
Pembroke Place, Liverpool L3 5QA
United Kingdom
Tel: +44 (0)151 705 3100
Fax: +44 (0)151 705 3370
E-mail: s.torr@liverpool.ac.uk

Dr Iñaki Tirados
Liverpool School of Tropical Medicine
Pembroke Place, Liverpool L3 5QA
United Kingdom
E-mail: I.Tirados@liverpool.ac.uk

University of Oxford
Spatial Ecology & Epidemiology Group (SEEG)
Department of Zoology, University of Oxford
South Parks Road, Oxford OX1 3PS
United Kingdom

Professor Simon Hay*
Professor of Epidemiology
Head of SEEG
E-mail: simon.hay@zoo.ox.ac.uk / simon.i.hay@gmail.com

Dr Nick Golding*
Postdoctoral Researcher
Tel.: +44(0)1865 271137
E-mail: nick.golding@zoo.ox.ac.uk / nick.golding@linacre.ox.ac.uk

University of Warwick
Gibbet Hill Road, Coventry, CV4 7AL
United Kingdom

Professor Matt Keeling
WIDER (Warwick Infectious Disease Epidemiological Research) Centre
Department of Biological Sciences & Mathematics Institute
E-mail: M.J.Keeling@warwick.ac.uk or MattJKeeling@gmail.com

Professor Katherine Rock
WIDER (Warwick Infectious Disease Epidemiological Research) Centre
Department of Biological Sciences & Mathematics Institute
E-mail: K.S.Rock@warwick.ac.uk

Professor Deirdre Hollingsworth
Associate Professor (Reader)
Mathematics Institute: Office: C2:15
Tel: +44 (0)24 765 22698
E-mail: Deirdre.Hollingsworth@warwick.ac.uk

Yale University

Alison Galvani
E-mail: alison.galvani@gmail.com

Abhishek Pandey*
E-mail: abhiganit@gmail.com

Oregon State University

Dr Jan Medlock
Associate Professor
E-mail: jan.medlock@oregonstate.edu

Institute for Disease Modeling (IDM)
3150 139th Ave SE, Bellevue, WA 98005
United States of America

Dr Philip Eckhoff*
Principal Investigator
E-mail: peckhoff@intven.com

Caitlin Bever
E-mail: cbever@intven.com

Implementing partners

Médecins Sans Frontières (MSF)

Dr Manica Balasegaram*
Executive Director, Médecins Sans Frontières Access Campaign
Rue de Lausanne 78, P.O Box 116
1211 Genève 21
Switzerland
Tel: +41 22 849 84 05
E-mail: Manica.BALASEGARAM@geneva.msf.org

Professor François Chappuis
Division of International and Humanitarian Medicine
Geneva University Hospitals
Rue Gabrielle-Perret-Gentil 6, 1211 Geneva 14
Switzerland
Tel: +41 22 372 96 20
Fax: +41 22 372 96 26
E-mail: Francois.Chappuis@hcuge.ch

Mrs Laurence Flevaud
Laboratory advisor, Médecins Sans Frontières Spain
Nou de la Rambla 26, 08001 Barcelona
Spain
Tel: +34 933 046 257
E-mail: Laurence.flevaud@barcelona.msf.org

Dr Marc Gastellu Etchegorry
Secrétaire médical international, Médecins Sans Frontières International
Rue de Lausanne 78, P.O Box 116
1211 Genève 21
Switzerland
E-mail: marc.gastellu@msf.org

Dr Nines Lima*
Tropical Diseases Advisor, Médecins Sans Frontières Spain
Nou de la Rambla 26, 08001 Barcelona
Spain
Tel: +34 93 3 046 100
E-mail: nines.lima@barcelona.msf.org

Dr Turid Piening
Health Advisor, Médecins Sans Frontières Germany
Am Köllnischen Park 1, 10179 Berlin
Germany
Tel: +49 (0)30 700 130 262
GSM: +49 (0)163 24 24 533
E-mail: turid.piening@berlin.msf.org

Mr Julien Potet
Médecins Sans Frontières Access Campaign
Rue de Lausanne 78, P.O Box 116, 1211 Genève 21
Switzerland
Tel: +41 22 849 8405
E-mail: Julien.POTET@paris.msf.org

Dr Michel Quere
Médecins Sans Frontières Switzerland
Rue de Lausanne 78, P.O Box 116, 1211 Genève 21
Switzerland
Tel: +41 22 849 84 84
E-mail: michel.quere@geneva.msf.org

International institutions

African Union Commission (AU) / Pan-African Tsetse and Trypanosomiasis Eradication Campaign (PATTEC)

PO Box 3243, Addis Ababa, Ethiopia

Dr Gif Wiseman Wanda
PATTEC Coordinator
E-mail: wandag@africa-union.org

Food and Agriculture Organization of the United Nations (FAO) / Programme Against African Trypanosomiasis (PAAT)

Viale delle Terme di Caracalla, Rome 00153, Italy

Dr Raffaele Mattioli*
Chief Animal Health Service
Tel: +39 (06) 57 05 60 78
E-mail: Raffaele.Mattioli@fao.org

Dr Giuliano Cecchi
Project Officer
Sub-regional Office for Eastern Africa
CMC Road, Next to ILRI, P.O.Box 5536
Addis Ababa
Ethiopia
Tel: +251 (0) 116 478888
Mob: +251 (0) 935 336069
Fax: +251 (0) 116 478800
E-mail: Giuliano.Cecchi@fao.org

International Atomic Energy Agency (IAEA) / Programme Against African Trypanosomiasis (PAAT)

Vienna International Centre, PO Box 100, 1400 Vienna, Austria

Mr Rafael Argiles Herrero*
Technical Officer, Insect Pest Control Section
Joint FAO/IAEA Division of Nuclear Techniques in Food and Agriculture
Department of Nuclear Sciences and Applications
Tel: +43 1 2600-21629
Fax: +43-1 26007|
E-mail: R.Argiles-Herrero@iaea.org

Dr Marc J.B. Vreysen
Laboratory Head, Insect Pest Control Laboratory
Joint FAO/IAEA Division of Nuclear Techniques in Food and Agriculture | Department of Nuclear Sciences and Applications
Tel: +43 (1) 2600-28404
Mob: +43 699-165-28404
E-mail: m.vreysen@iaea.org

Donors

Bayer AG

Dr Michael Schöettler*
Head, Global Health Policy & Public Affairs
Bayer HealthCare Aktiengesellschaft
BHC-COM-HP&PA, 51368 Leverkusen, Q 30
Germany
Tel: +49 214 30 72511
Mob: +49 175 30 72511
Fax: +49 214 30 9672511
E-mail: michael.schoettler@bayer.com

Dr Klaus Brill*
Vice-President, Corporate Commercial Relations
Bayer AG, Bayer HealthCare Pharmaceuticals
BPH-CCR, 13333 Berlin
Germany
Tel: +49 30 468 16985
Mob: +49 172 223 01 48
Fax: +49 30 468 96985
E-mail: klaus.brill@bayer.com

Dr Ulrich Dietmar-Madeja
Executive Director Access to Medicines
Bayer AG, Bayer HealthCare Pharmaceuticals
Social Health Care Programs (CCR-SHCP)
Müllerstr. 178, M069, R508, 13353 Berlin
Germany
Tel: +49 30 468 11803
Mob: +49 172 3037 537
Fax: +49 30 468 11450
E-mail: ulrich-dietmar.madeja@bayer.com

Sanofi

9, rue du Président Allende, 94256 Gentilly Cedex, France

Dr Robert Sebbag
Vice-President, Access to Medicines
Tel: +33 1 41 24 57 78
E-mail: robert.sebbag@sanofi.com

Dr Guillermo Doll
Director, Tuberculosis and Neglected Tropical Disease Programmes
Access to Medicines
Tel: +33 155 71 31 01
Mob: +33 6 32 23 21 82
Fax: +33 1 41 24 57 84
E-mail: Guillermo.Doll@sanofi.com

Dr Valerie Robin
Regulatory affairs
Access to Medicines

Mr Martin BERNHARDT*
Vice President, Relations with International Institutions
15 chemin Louis-Dunant, 1211 Geneva 20
Switzerland
Tel: +41 22 910 33 53
Mob: +41 79 430 19 45
E-mail: martin.bernhardt@sanofi.com

Bill & Melinda Gates Foundation

PO Box 23350, Seattle, WA 98102, United States of America

Dr Donald Bundy
Deputy Director and Senior Advisor, NTDs, Global Health
Tel: +1 206 726 7337 / +1 206 849 7834
E-mail: donald.bundy@gatesfoundation.org

Ms Susan Linna
Portfolio and Platform Lead Strategy, Planning & Management
Global Health Program
Tel: +1 206 77-2330
Mob: +1 301 928 9053
E-mail: Susan.linna@gatesfoundation.org

Dr Matthew Steele
Senior Program Officer
Global Health, Neglected Tropical Diseases
E-mail: matthew.steele@gatesfoundation.org

Dr David Wesche
E-mail: david.wesche@gatesfoundation.org

Dr Noelle Huskins
Program Officer
Neglected Tropical Diseases
Tel: +1 206 770 1834
Mob. +1 206 605 8312
E-mail: noelle.huskins@gatesfoundation.org

General Electrics

Ms Sofie Stille*
Business Leader, BioProcess Media
GE Healthcare Filial Sverige
jörkgatan 30, (Box 605), SE-751 25 Uppsala,
Sweden
Tel: +46 18 612 0000
E-mail: Sofie.Stille@ge.com

Mr Graziano Bonetti
GE Healthcare Filial Switzerland

Veestergard Frandsen

Mr Torben V. Frandsen*
Vestergaard Frandsen Group
Director of Development
Haderslevvej 36, 6000 Kolding
Denmark
Tel: +45 75 503050
E-mail: tvf@vestergaard-frandsen.com

Mr Allan Mortensen*
Vestergaard, Managing Director
Chemin Messidor 5-7, 1006 Lausanne
Switzerland
E-mail: amo@vestergaard.com

Dr Georgina Bingham Zivanovic*
Senior Technical Specialist & Global Partnerships
Food Security, Vestergaard
Chemin Messidor 5-7, 1006 Lausanne
Switzerland
Tel: +41 (0) 21 310 7331
Mob: +41 79 824 2032
E-mail: gvb@vestergaard.com

Belgian Development Cooperation

Dr Ignace Ronse*
Directorate-General Development
DG Development
Belgian Development Cooperation
Rue des Petits Carmes 15, 1000 Brussels
Belgium
E-mail: ignace.ronse@diplobel.fgov.be

Swiss Agency for Development and Cooperation (SDC)

Dr Susanna Hausmann Muela*
Senior Health Advisor, Federal Department of Foreign Affairs
Regional Cooperation, Department East and Southern Africa
Freiburgstrasse 130, 3003 Bern
Switzerland
Tel: +41 31 322 10 68
Fax: +41 31 323 17 64
E-mail: susanna.hausmann@eda.admin.ch

Norwegian Agency for Development Cooperation (NORAD)

Ruseløkkveien 26, 0251 Oslo, Norway

Mari Grepstad*
E-mail: Mari.Grepstad@norad.no

Department for International Development (DFID)

22 Whitehall, London SW1A 2EG, United Kingdom

Sue Kinn*
E-mail: S-Kinn@dfid.gov.uk

Federal Ministry of Education and Research (BMBF)

Lena Hoefling*

E-mail: Lena.hoefling@kfw.de

The Wellcome Trust

Professor Mike Turner*

Head of Infection and Immuno-biology

Gibbs Building, 215 Euston Road, London NW1 2BE

United Kingdom

Tel: +44 (0)20 7611 8273

E-mail: m.turner@wellcome.ac.uk

WHO Strategic and Technical Advisory Group for Neglected Tropical Diseases

Professor Peter Holmes*

Ex Chairman of the Strategic and Technical Advisory Group/Pro Vice-Principal

University of Glasgow

13 The Square, University Avenue, Glasgow G12 8QQ

United Kingdom

Tel: +44 141 330 3836

E-mail: Peter.Holmes@glasgow.ac.uk

Dr Anne C. Moore

Member of the Strategic and Technical Advisory Group

Parasitic Diseases Branch, Division of Parasitic Diseases and Malaria

Center for Global Health, Centers for Disease Control and Prevention

1600 Clifton Road, Atlanta GA 30333, United States of America

Tel: +1 404-718-4793

E-mail: aym2@cdc.gov / moorea1078@bellsouth.net

World Health Organization

WHO headquarters

20 Avenue Appia, 1211 Geneva 27, Switzerland

Dr Minghui Ren

Assistant Director-General

Tel: +41 22 791 10 99 Operator: +41 22 791 2111

Fax: +41 22 791 2111

E-mail: renm@who.int

Dr Dirk Engels

Director, Department of Control of Neglected Tropical Diseases

Tel: +41 22 791 38 24 Operator: +41 22 791 2111

Fax: +41 22 791 47 77

E-mail: engelsd@who.int

Dr Daniel Argaw Dagne

Coordinator, Innovative & Intensified Disease Management

Tel: +41 22 791 45 32 Operator: +41 22 791 2111

Fax: +41 22 791 47 77

E-mail: daniel@who.int

Dr José Ramon Franco Minguell

Medical Officer, Human African Trypanosomiasis Programme

Innovative & Intensified Disease Management

Tel: +41 22 791 33 13 Operator: +41 22 791 2111

Fax: +41 22 791 47 77

E-mail: francoi@who.int

Dr Gerardo Priotto

Medical Officer, Human African Trypanosomiasis Programme

Innovative & Intensified Disease Management

Tel: +41 22 791 13 45 Operator: +41 22 791 2111

Fax: +41 22 791 47 77

E-mail: priottog@who.int

Miss Lise Grout
Technical Officer, Innovative & Intensified Disease Management
Tel: +41 22 791 23 41 Operator: +41 22 791 2111
Fax: +41 22 791 47 77
E-mail: groutl@who.int

Dr Pere P Simarro
Consultant
E-mail: simarropp@gmail.com

Dr Jorge Atouguia
Consultant
E-mail: j.atouguia@gmail.com

Dr Jean Jannin
Ex Coordinator, Innovative & Intensified Disease Management
E-mail: jeanjannin74@gmail.com

WHO Regional Office for Africa

Dr Benido Impouma*
Regional Adviser
NTD/AFRO, B.P. 6, Brazzaville
Congo
Tel: +4724139773
E-mail: impoumab@who.int

Dr Abdoulaye Diarra
Medical officer
IST/WHO Regional focal point for HAT
PO Box 820, Libreville
Gabon
Tel.: +241 62 34873
E-mail: diarraa@who.int

Dr Augustin Kadima Ebeja
NPO THA MTN PCC OMS RDC
Kinshasa
République Démocratique du Congo
Tel: +243 810 81 22 38
kadimaebjaa@who.int

* Unable to attend

